

Programmable Operator Interface

MONITOUCH

Safety Considerations

- For safe operation, read the instruction manual or user manual that comes with the product carefully or consult the distributor from which you purchased the product, before using the product.
- Products introduced in this catalog have not been designed or manufactured for such applications in a system or equipment that will affect human bodies or lives.
- Customers, who want to use the products introduced in this catalog for special systems or devices such as for atomic-energy control, aerospace use, medical use, passenger vehicle, and traffic control, are requested to consult the Hakko Overseas Sales Section.
- Customers are requested to prepare safety measures when they apply the products introduced in this catalog to such systems or facilities that will affect human lives or cause severe damage to property if the products become faulty.
- For safe operation, wiring should be conducted only by qualified engineers who have sufficient technical knowledge about electrical work or wiring.

Notes to consider before purchasing

- Appearance and specifications are subject to modification without prior notice due to technical improvements.
- Colors in the catalog may differ from the actual colors due to printing inaccuracies.
- Consult your distributor or us for further information about products in this catalog.

www.monitouch.com

Hakko Electronics Co., Ltd.

Overseas Sales Department
890-1 Kamikashiwano-machi,
Hakusan, Ishikawa 924-0035, Japan

- Tel
+81-76-274-2144
- Fax
+81-76-274-5136
- E-mail
sales@hakko-elec.co.jp

Distributor

* Product specifications and design are subject to modification.
* Combined images are used for the screen images.
* Product colors may differ from colors in brochure photos due to printing.
* Windows and Excel are trademarks of Microsoft (USA) in the U.S. and other countries.
* Other company and product names in this brochure are registered trademarks.
* Printed with environment-friendly soy ink.



V9 series
V9 makes automation complete.

Hakko Electronics Co., Ltd.

The new MONITOUCH series scales new heights of excellence; optimum operability, intuitive controls, and extended capability to display and utilize your application.

On its release in 1988 as the first ever programmable display*, MONITOUCH augured in a new era of human-machine interface technology. It is now used as an information terminal for countless different purposes in production sites all over the world. The total number of shipments has reached around one million.

Now, Hakko Electronics Co., Ltd. has introduced its new range with an impressive array of exciting new cutting-edge features expressly designed to meet the needs of our clients.

The MONITOUCH PREMIUM series, the next generation of programmable displays, is here.

*According to our own research.



V9 Standard
High performance model

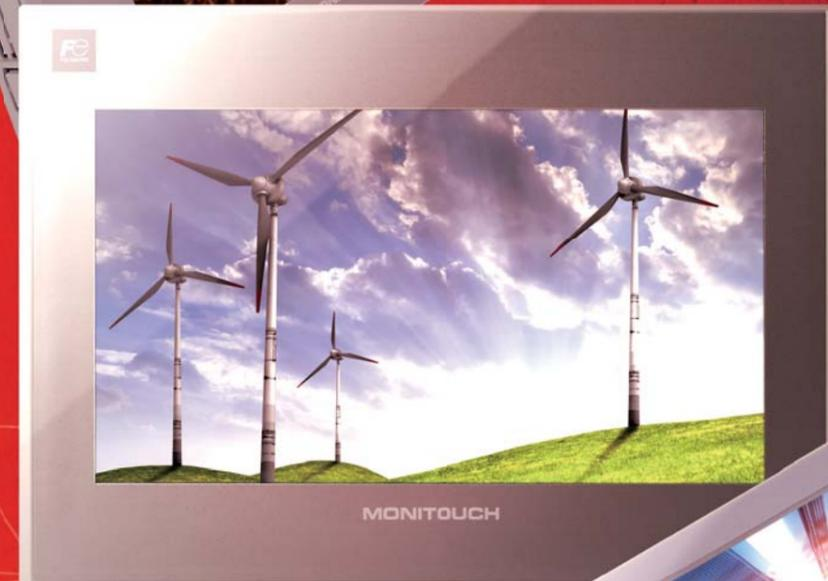

V9 Advanced
High resolution widescreen LCD with wireless LAN



V9 Lite
Basic model

MONITOUCH V9 series

04..... V9: Lineup	18..... V9: Specifications	28..... V8: Dimensions & Parts Names
06..... V9: Features 1	20..... V9: System Configuration	29..... V8: Accessories
08..... V9: Features 2	22..... V9: Dimensions & Part Names	30..... PLC Connection - Summary
10..... V9: Extended Functions 1	24..... V9: Product Details	32..... Temperature Controller / Servo / Inverter Connection - Summary
12..... V9: Extended Functions 2	25..... V9: Accessories	34..... Service & Support
14..... V-SFT Ver.6	26..... V8: Lineup	35..... Product Warranty
17..... V9: Optional Units	27..... V8: Specifications	

We provide a wide range of display, with wide
The V9 series lineup helps to establish the most
fulfilling the needs of automation.

range of functionalities.
efficient information system

V9 Advanced

V9 Standard

V9 Lite

10.1 inches

- V9101iWRLD DC
- V9101iWLD DC

7 inches

- V9071iWRLD DC
- V9071iWLD DC

15 inches

- V9150iX AC
- V9150iXD DC

12.1 inches

- V9120iS AC
- V9120iSD DC



To be released in April 2015

10.4 inches

- V9100iS AC
- V9100iSD DC

8.4 inches

- V9080iSD DC

10.4 inches

- V9100iC AC
- V9100iCD DC

8.4 inches

- V9080iCD DC

5.7 inches

- V9060iTD DC



To be released in April 2015

Model	V9101iW	V9071iW	V9150iX	V9120iS
Display size	10.1" wide	7" wide	15"	12.1"
Display device	TFT color LCD	TFT color LCD	TFT color LCD	TFT color LCD
Resolution W:H (dots)	1024×600	800×480	1024×768	800×600
Colors	16.7 million ^{*1}	16.7 million ^{*1}	16.7 million ^{*1}	16.7 million ^{*1}
Touch switch	Capacitance	Capacitance	Analog resistance film	Analog resistance film
Screen memory (FROM)	64MB	64MB	64MB	64MB
Backup memory (SRAM)	800KB	800KB	800KB	800KB
Ethernet (LAN)	○	○	○	○
Extended cable LAN	○	○	△ ^{*2}	△ ^{*2}
Wireless LAN	△ ^{*2}	△ ^{*2}	△ ^{*2}	△ ^{*2}
Serial (CN1)	RS-232C/422/485	RS-232C/422/485 ^{*3}	RS-232C/422/485	RS-232C/422/485
Serial (MJ1)	RS-232C/485	RS-232C/485	RS-232C/485	RS-232C/485
Serial (MJ2)	RS-232C/485	RS-232C/422/485	RS-232C/485	RS-232C/485
Communication I/F	○	○	○	○
Optional unit I/F (GUR-XX)	○	—	○	○
SD card I/F	○	○	○	○
USB (Type A)	○	○	○	○
USB (Type mini-B)	○	○	○	○
Sound output	○	—	○	○

Please refer to page 24 for the details of each model.

V9100iS	V9080iSD	V9100iC	V9080iCD	V9060iTD
10.4"	8.4"	10.4"	8.4"	5.7"
TFT color LCD	TFT color LCD	TFT color LCD	TFT color LCD	TFT color LCD
800×600	800×600	640×480	640×480	640×480
16.7 million ^{*1}	16.7 million ^{*1}	16.7 million ^{*1}	16.7 million ^{*1}	260 thousand ^{*1}
Analog resistance film	Analog resistance film	Analog resistance film	Analog resistance film	Analog resistance film
64MB	64MB	64MB	64MB	64MB
800KB	800KB	800KB	800KB	800KB
○	○	○	○	○
△ ^{*2}	△ ^{*2}	—	—	—
△ ^{*2}	△ ^{*2}	—	—	—
RS-232C/422/485	RS-232C/422/485	RS-232C/422/485	RS-232C/422/485	RS-232C/422/485 ^{*3}
RS-232C/485	RS-232C/485	RS-232C/485	RS-232C/485	RS-232C/485
RS-232C/485	RS-232C/485	RS-232C/485	RS-232C/485	RS-232C/422/485
○	○	○	○	○
○	○	—	—	—
○	○	○	○	○
○	○	○	○	○
○	○	—	—	—

*1: Only for pictures, 3D parts and videos. Other items are displayed in 65,536 colors. *2: Depending the model. *3: When optional unit DUR-00 is installed.

Kindness to our customers is the origin of

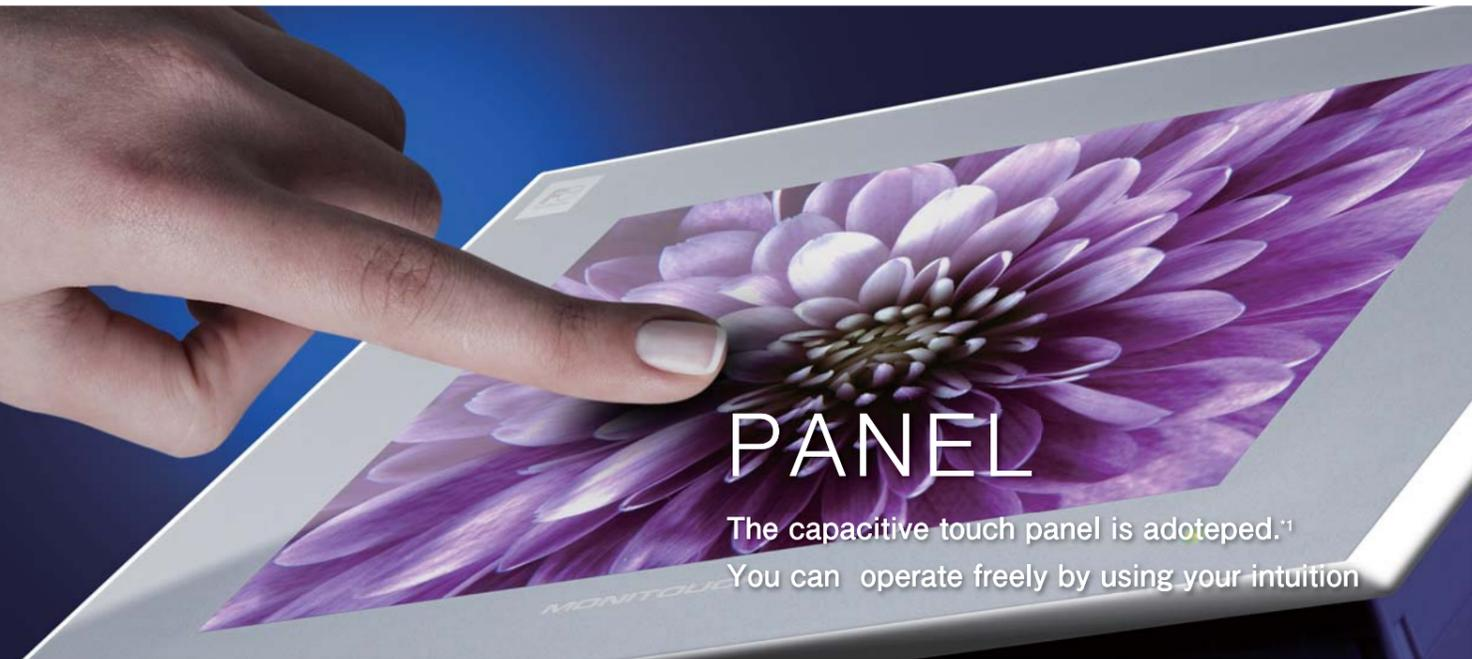

PANEL
The capacitive touch panel is adopted.^{*1}
You can operate freely by using your intuition

*1: Only V9 advanced model.

Smooth Operation with Your Fingers

Zooming In and Out with Two Fingers V9 Advanced

The displayed image can be magnified up to 200% by pinching out the screen^{*2}, and reduced to the original size by pinching it in.

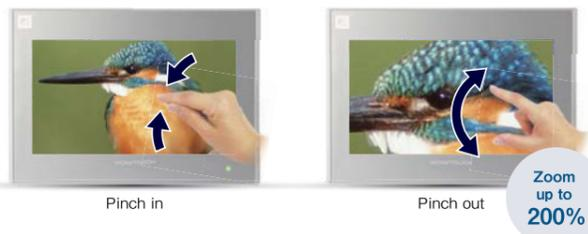

*2: The image can be scaled up and down by double tapping for V9 Standard/Lite.

Scrolling Magnified Images

You can view a particular part of a magnified image in close-up while scrolling around the screen.



Abundant Quantity of Information

Displaying Four Times the Screen Size First in industry

Twice in width

Twice in height

The whole area of a large image can be confirmed easily by scrolling the screen without the need of switching it. The navigation window helps you to recognize the current displayed position instantly.

Information Max. 4 times

4 times in width

4 times in height

*3: According to our own research.

Widescreen LCD V9 Advanced

V9 Advanced models is equipped with a high-precision, high-resolution widescreen (16:9). Greater volume and variety of information can be displayed on the screen.



evolution of MONITOUCH.

Enhanced Display Capacity

TrueType Fonts for Clear Expression

TrueType fonts have been added, and the new anti-aliasing function ensures clear expression. There is no need to worry about memory capacity, because TrueType fonts need less memory compared with Windows fonts.



PDF Viewer Function

PDF files stored on SD cards can be displayed. PDF instruction manuals can be used for troubleshooting.

Reading PDF file

Convenient

Fast navigation to the desired page, using bookmarks.

7-segment Fonts for Realistic Expression

7-segment fonts allow for realistic, highly visible expression of measuring instruments.

Non-illuminated segments can be shown in a subtle color.

Video/RGB Input-Output Support

By attaching an optional unit, videos and RGB images can be displayed on the V9. Also, images displayed on the V9 can be sent to external displays.

Supports 16.7 million colors

Optional unit

Model	Item
GUR-04	Video IN : 1CH
GUR-01	RGB IN : 1CH
GUR-02	RGB OUT : 1CH

*4: The GUR-01 supports 65,536 colors.

Versatile Screen Transition Functions

15 kinds^{*5} of functions are available for screen switching and overlapping.

E.g.) Slide-in

15 kinds of screen change

*5: Four types for overlapping windows.

Compatible with Vertical Placement

The screen can also be displayed and edited while the panel is placed vertically (by left or right turning).

E.g.)

Main Menu Screen can also be displayed vertically.

For all models

V9101IW V9100IS

COLOR

Displays 16.7 million colors^{*6} for delicate expression of gradation



*6: For the display of pictures, 3D parts and video/RGB images only. Other parts are displayed in 65,536 colors.

Easy and safe network monitoring and control



VNC Server Function

Remote Connection from Tablet PCs

All types of the V9 series are equipped with VNC server function for remote monitoring and control of production from your tablet PC.



Wireless LAN Function

Wireless Data Transfer

By connecting a PC to a V9 via wireless LAN, transmission of screen program and the reading and writing of files through FTP server/client functionality becomes available. On-site debugging can be conducted easily, without the need for a cable connection.



Data Transfer via V9 Panels

With macro EREAD/EWRITE, data can be transferred between machines using V9 panels as a gateway.

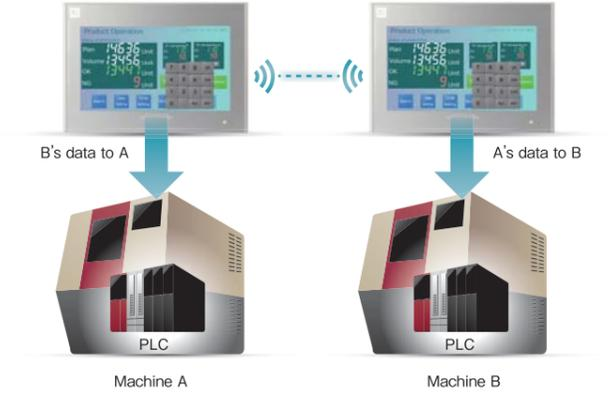

Networking

Secure, easy and low cost remote control by VPN

MONITOUCH, equipped with VPN (Virtual Private Network) function, facilitates secure remote control through a public network. In addition, VPN's routing function enables a V9 series unit to connect with PLC and network cameras via Ethernet.

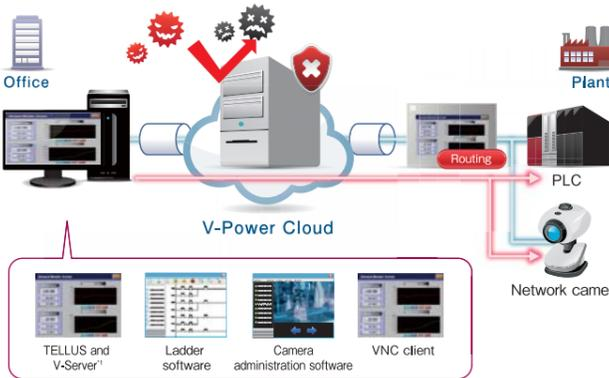

*1 TELLUS and V-Server for V9 is under development.

E-mail Transmission Function

E-mails can be sent to preset addresses when alarms are issued or lifted. Addresses can be set for each type of alarm.



Secure Enhanced Security
SSL/TLS transmission is supported, so you can work with peace of mind.

Ladder Program Transmission (3-way) Support

Up to 3 PLCs are accessible to monitor and revise PLC programs by connecting a PC to V9 via Ethernet.

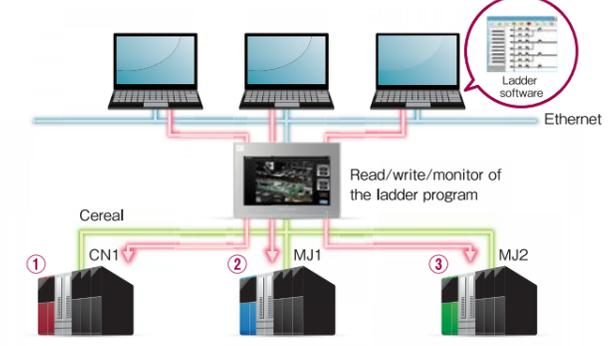

FTP Server/Client Support

FTP Server Function

Files in a storage media inserted in a V9 can be read out and written using a PC.

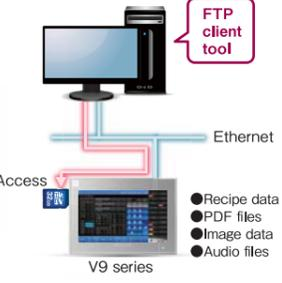

FTP Client Function

Files on an FTP server can be read and written using a V9. It is also possible to use a V9 as an FTP server and access its stored data.



Easy verification of daily data and error reports



LOGGING

Improved functions for displaying trend data and alarms

Screen Overlapping

Improved Overlapping Functions

Up to 10 windows can be overlapped on the screen. No limit on the size of each window.

You can make all ten windows transparent at the same time.

All of the ten windows can be left displayed even when the screen is changed.



10 windows at once

Select items to display constantly.

Trend Data Display

Backup Data Display



Backup files can be loaded and displayed on V9. Alarm backup data can also be displayed.



Coordination with the Scheduler

Operations such as bit output and execution of macro programs can be scheduled on a specific date and time. Also, start and stop of logging, and data saving can be conducted by setting the logging conditions.

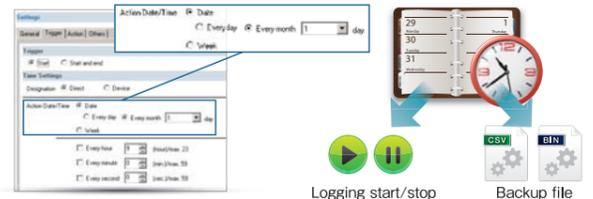

Logging start/stop Backup file

Easy Creation of Backup Files

By using the scheduler, backup files are automatically created at scheduled timings.

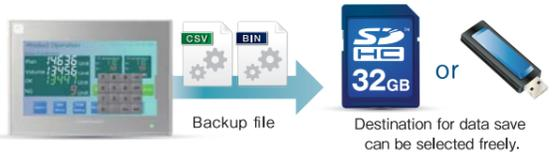

Magnification of Trend Graph Scale

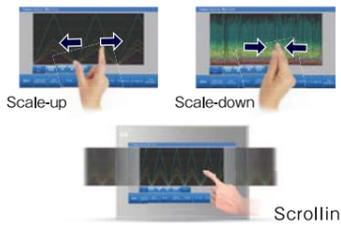

The time scale of trend graph can be magnified, and the display can be scrolled by touch and drag.

Four-times of Normal Overlapping Windows

Four times more information than of normal overlapping windows can be registered and used as sub screen.



Various Screen Transition Functions

Four kinds of functions such as slide-in and fade-out are available for screen switching and overlapping.



Alarm Display

Scrolling of the Alarm Messages



The entire alarm message can be displayed by scrolling the screen with touch and drag.

Scrolling the alarm messages

Running Emergency Messages



Alarm messages run automatically at a specified position when alarms are occurred.

Convenient tools for scrolling

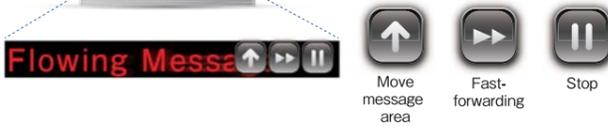

OVERLAP

Exponentially improved display performance by extended functions



Easy and smooth operation with new functions

SETTING

Various setting functions for improving usability

Unit Display

Display of V9 Status

The status of V9 is displayed in the status bar.^{*3}

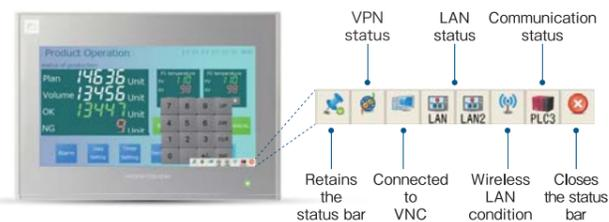

*3: The contents of the status indication are subject to change.

System Keyboard Available

A versatile keyboard for inputting upper and lower case letters and numbers is available for easy setting.

Select the system keyboard from the set menu.



Local Screen Settings

Transmission Settings

Transmission settings with connected devices can be modified on the V9.

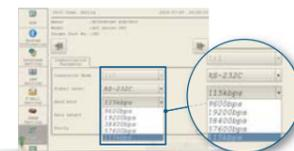

Communication setting

Backlight Settings

Backlight settings can be modified on the V9.



Backlight setting

Buzzer Settings

Buzzers settings can be modified on the V9.



Buzzer setting

Operation Log

Improved Operation Log Viewer

The operability and visibility of the log viewer have been improved.

Log display area
Double-tapping for displaying details

Title line
Filtering for each item.

File change
A log file selected for display

Setting
Viewer display setting

Search Function

Operation log can be searched for by specifying an operator or date and time.



Filter/Sort Settings

Filter and sort can be set for displayed items.

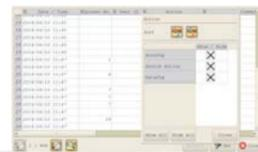

Display Item Settings

It is possible to select which items in the operation log to display, or not.



Recipe

Global Control Function

The ability to read and write to specified files and record data, regardless of the screen displayed, can be turned on or off using BITS.

Recipe file

① MO (BITS) ON

V9 series

② Transfer of the recipe data to D100, and onwards

Transferring recipe data to the PLC

D100	150
D101	30
D102	10
D119	5

Filter Settings

The required data can be easily extracted using the recipe selection list dialog to narrow down file and record searches.

Convenient

INFORMATION

Visualizing information for prompt recognition

Simple configuration of beautiful screens

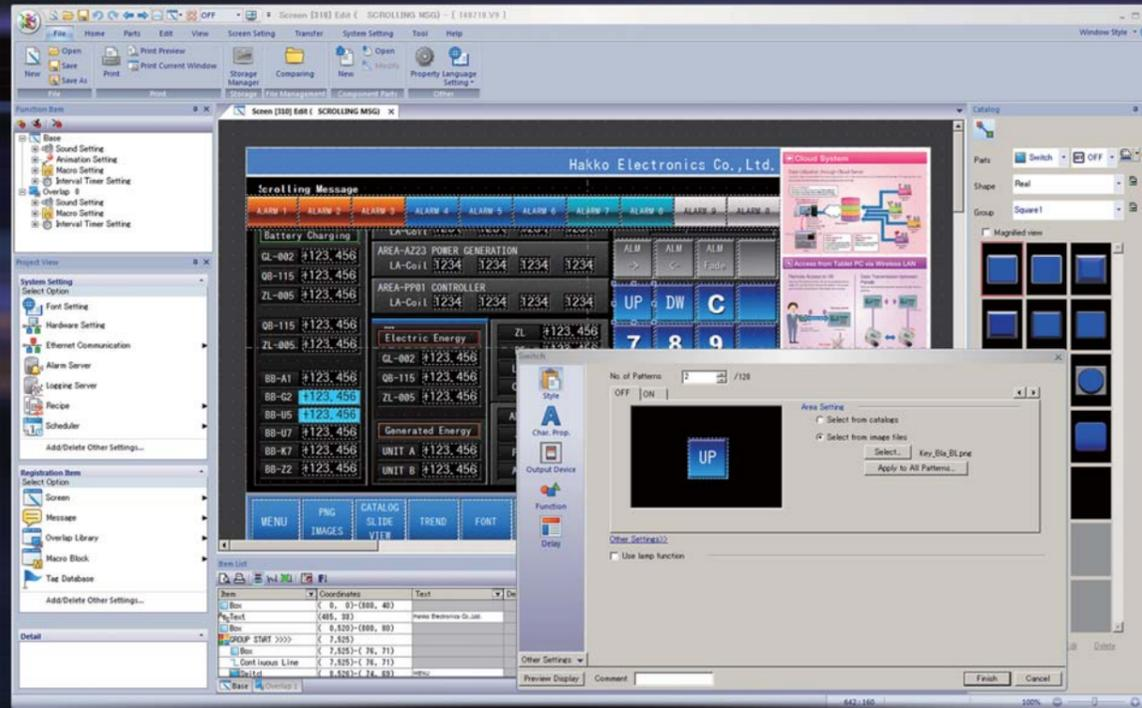

V-SFT ver.6

PC	PC/AT compatible machine with Windows
OS*	Windows XP/ XP 64Edition/ Vista 32bit/ Vista 64bit/ Win 7 32bit/ Win 7 64bit/ Win 8 32bit/ Win 8 64bit/ Win 8.1 32bit/ Win 8.1 64bit
CPU	Pentium 4 2.0GHz or higher recommended.
Memory	2.0GB or more
Hard disk	For installation: 2.0GB or more available space

*1: For installing the OS, administrator authority is required.

Disc drive	DVD-ROM drive
Display	Resolution: 1024×768 (XGA) or more
Color indication	High color (16 bit) or higher
Others	Microsoft .NET Framework 4.0 or 4.5 is required. (When .NET Framework 4.0 or 4.5 has not been installed in PC, Framework 4.0 is installed automatically.)

Compatibility with Previous Models

V8 series Compatibility

V-SFT Ver. 6 provides intuitive operation, with easy-to-use visual tools and refined displays. In addition to the V9 series, V-SFT Ver. 6 is also compatible with the V8 series.

Compatible with Data from Former Models

Screen data produced using previous versions of V-SFT can be converted for use in the current model. It is possible to use former screen data assets.

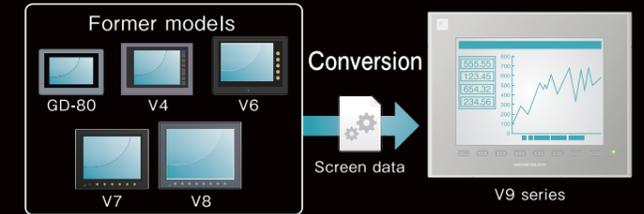

Configuration of Easy-to-view Screens

Wider Range of Parts

The number of picture icons has been increased, and the icons with plain design have been added. Pick from the wide range of ready-made icons for sophisticated representation.



Configuration of beautiful screens

Simple icons added

Popular simple icons that are used widely on smartphones have been introduced.



Increased picture icons

The number of the picture icons has been increased.



Improved 3D Parts Scaling Function

3D parts can be scaled up and down without changing the widths of frames. Frame size can be modified by batch, or individually according to the item type.

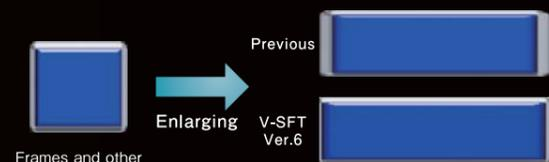

*1: For V9 series square picture icons and 3D parts with frames (excluding some icons and parts)

Line Width Setting

The line widths of graphic items and trend items (graph lines, reference lines) can now be set in eight steps. Effective screens can be created using a variety of drawing tools and graph representations.

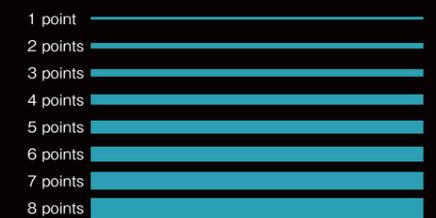

*2: Excluding thick lines

Copy/Paste of Microsoft Office Data

Graphics created in Microsoft Office Word, Excel and PowerPoint can be copied and pasted into V-SFT files by converting them to pictures, patterns or parts.

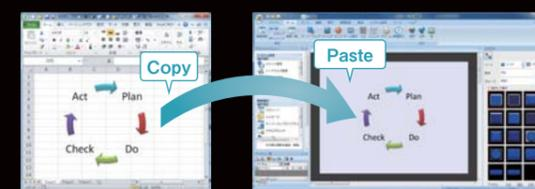

Pasting of an Image File

It is possible to paste a PNG file directly onto the screen. JPG, BMP and GIF formats are also supported as image files, allowing you to create whatever visually impressive screen you choose.

Upgraded Operability

Ribbon Menu

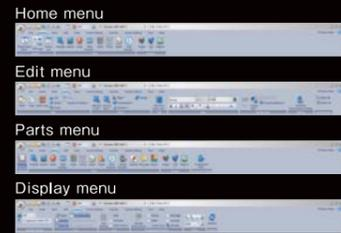

The ribbon-shaped menu bar is available. Enlarged icons are easily visible also improves the operability remarkably.

Graphic Indication of System Configuration

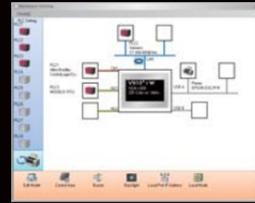

The improved hardware setting screen makes it easy to grasp exactly how devices are connected together in the system.

Docking Windows



The project view windows and item view windows can be docked or floated easily.

Integration of Search Menu



The search menu, which used to be displayed separately, have now been integrated for easy operation.

Enhanced Interlocking Setting

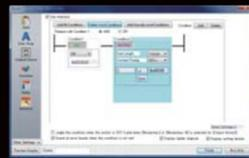

Interlock can be set with a ladder drawing screen. Multiple conditions for interlocking can be easily set. It is possible to set interlocking for keypad indication conditions in addition to switch conditions. Up to five conditions (AND or OR) for a bit device, word device or security device can be set, which is suitable for setting complicated conditions.

Character String Table



Text for switches, lamps and other parts can be managed centrally using the character string table. Frequently used text can be registered in the table for easy reference and batch modification.

*1: Switches, lamps, text, and multi text only.

Facilitation of Screen Configuration

Guided Setting Process

With the help of the clear instructions in the dialog, setting can be conducted smoothly and collectively.



A Wider Range of Colors for 3D parts

65,536 colors are available for 3D Parts.

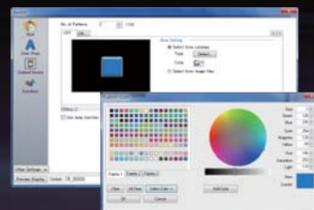

Visualization of Setting

Set conditions can be confirmed on the preview screen before completing setting. By switching the preview screen and setting dialog, the setting can be confirmed easily even on a PC with low resolution.

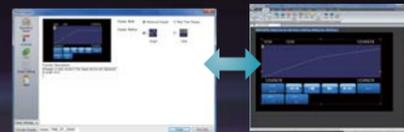

Tool Hints to Support Configuration

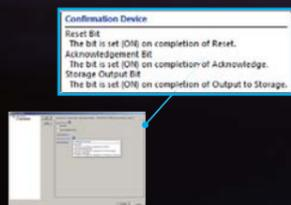

Tool hints are provided at many points to support configuration. When you hover the mouse over the item, a hint for operation will appear. You can learn the procedure for configuration without referring to the manual.

Direct Editing with the Item View



In the item view, an indication range and component parts consisting of various parts including switches are selected. Since there is no need to select various items respectively, smooth and efficient editing is possible.

Optional Units

Extension Units

GUR-00 (Video input 4ch)²

Displays images from video cameras on V9 directly.

GUR-01 (RGB input 1ch)

Displays RGB input on V9.

GUR-02 (RGB output 1ch)

Displays images of V9 on a monitor.

GUR-04 (Video input 1ch)

Displays images from a video camera directly.

GUR-10 (Video input 2ch + RGB input 1ch)²

Displays images from video camera and RGB input on V9 simultaneously.

GUR-11 (RGB input 2ch)²

Displays RGB images such as PC images through two channels on V9 simultaneously.

²: Scheduled for development.

Communication Units

CUR-00 OPCN-1

CUR-04 PROFIBUS-DP (To be released in April 2015)

CUR-01 T-link

CUR-06 SX bus

CUR-02 CC-Link (To be released in April 2015)

CUR-07 DeviceNet (To be released in April 2015)

CUR-03 Ethernet

CUR-08 FL-net

Configuration software

V-SFT-6 (Ver.6)

WindowsXP/ XP 64Edition/ Vista 32bit/ Vista 64bit/ Win7 32bit/ Win7 64bit/ Win8 32bit/ Win8 64bit/ Win 8.1 32bit/ Win 8.1 64bit

Cables

Type	Configuration	Connected to
V-CP	RS-232C Modular 8pin D-Sub9pin(F) Length: 3m	PC
V6-BCD	RS-232C Modular 8pin Length: 3m	Bar code reader
V6-MLT	RS-485 Modular 8pin Length: 3m	MONITOUCH V9/V8/V7/V6
V6-TMP	RS-232C/485 Modular 8pin Length: 3·5·10m	Temperature controller, inverter, etc.
UA-FR	Type A Length: 1m	Card reader/writer, USB memory, etc.

DUR-00 (Dedicated optional unit for V9071iW/ V9060iTD)

Used for serial connection with D-Sub9pin.

Other Units



TC-D9 (Terminal converter)

Connects V9 with other units via RS-422/485 terminal.



V9-BT

A replacement lithium battery for V9 series.
*Excluding the V9071iW and V9060iTD.



V7-BT

A replacement lithium battery for the V9071iW, V9060iTD and V8 series.



V9xxx-GS/V9xxx-GSN10

Protection sheets for panels (5 sheets per set). N10 is a non-glare type sheet. See P25 for details.

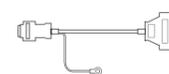

D9-D25

Replacement cable for CN1 cable of V6/V7 series.



Panel adapter (PAD-Vxxx)

Used when fitting V9 into V4/GD-80/GD-65/GD-64 panel cutout. Contact our technical helpdesk for details.



V9-ANT

Antenna for V9 models compatible with wireless LAN.

High-end specifications realize smooth

and accurate operation.

General Specifications

Item	V9 Advanced		V9 Standard			
	V9101iW	V9071iW	V9150iX	V9150iXD	V9120iS	V9120iSD
Power supply	Rated voltage		24V DC			
	Permissible range of voltage		±10%			
Insulation resistance			DC500V 10MΩ or more			
Physical environment	Ambient temperature		0~50°C ^{*1}			
	Ambient humidity		85%RH or less (without dew condensation) ^{*1}			
	Operation altitude		2,000 meters or lower			
	Atmosphere		Not to be exposed to corrosive gas, or conductive dust			
	Storage temperature		-10~60°C ^{*1}			
	Storage humidity		85%RH or less (without dew condensation) ^{*1}			
Contamination level		Level 2				
Mechanical operating conditions	Resistance to oscillation		Complies with JIS B 3502 (IEC61131-2) Vibration frequency: 5~9Hz, pulsating with:3.5mm, Vibration frequency: 5~9Hz, half amplitude: 3.5mm, vibration frequency: 9~150Hz, constant acceleration: 9.8m/s ² (1G), X, Y, Z: 3 directions (10 times each)			
	Resistance to shock		Complies with JIS B 3502 (IEC61131-2) Peak acceleration: 147m/s ² (15G), X,Y,Z: 3 directions, three times each (18 times in total)			
Electric operating conditions	Resistance to noise		Noise voltage:1,000Vp-p, pulse width:1μs, pulse rise time : 1ns			
	Resistance to static Discharge		Complies with IEC61000-4-2, contact: 6kV, air: 8kV			
Installation conditions	Grounding		Grounding resistance: Less than 100Ω, FG/SG separation		Grounding resistance: Less than 100Ω, FG=SG	
	Structure		Protect structure: Front case: IP66 (when water-proof gasket is used), Rear case: IP20, single unit, installation method: panel mounting			
	Cooling system		Natural air cooling			
	Dimensions W×H×D (mm)		278.5×198.5×54.4		201.6×147.6×60.3	
Panel cutout (mm)		257.0×183.0(+0.5/-0)		187.2×133.4(+0.5/-0)		
Case color		Light gray		-		
Material		PC		Front case: Aluminum, Rear case: PC resin		

*1: Wet-bulb temperature should be 39°C or lower to prevent malfunction.

V9 Standard			V9 Lite			
V9100iS	V9100iSD	V9080iSD	V9100iC	V9100iCD	V9080iCD	V9060iTD
100-240V AC			24V DC			
-15%,+10%			±10%			
DC500V 10MΩ or more			DC500V 10MΩ or more			
0~50°C ^{*1}			0~50°C ^{*1}			
85%RH or less (without dew condensation) ^{*1}			85%RH or less (without dew condensation) ^{*1}			
2,000 meters or lower			2,000 meters or lower			
Not to be exposed to corrosive gas, or conductive dust			Not to be exposed to corrosive gas, or conductive dust			
-10~60°C ^{*1}			-10~60°C ^{*1}			
85%RH or less (without dew condensation) ^{*1}			85%RH or less (without dew condensation) ^{*1}			
Level 2			Level 2			
Complies with JIS B 3502 (IEC61131-2) Vibration frequency: 5~9Hz, pulsating with:3.5mm, Vibration frequency: 5~9Hz, pulsating width: 3.5mm, acceleration: 9.8m/s ² (1G), X, Y, Z: 3 directions (10 times each)			Complies with JIS B 3502 (IEC61131-2) Peak acceleration: 147m/s ² (15G), X,Y,Z: 3 directions, three times each (18 times in total)			
Noise voltage: 1,000Vp-p, pulse width: 1μs, pulse rise time: 1ns			Noise voltage: 1,000Vp-p, pulse width: 1μs, pulse rise time: 1ns			
Complies with IEC61000-4-2, contact: 6kV, air: 8kV			Complies with IEC61000-4-2, contact: 6kV, air: 8kV			
Grounding resistance: Less than 100Ω, FG/SG separation			Grounding resistance: Less than 100Ω, FG/SG separation			
Protect structure: Front case: IP66 (when water-proof gasket is used), Rear case: IP20, single unit, installation method: panel mounting			Protect structure: Front case: IP66 (when water-proof gasket is used), Rear case: IP20, single unit, installation method: panel mounting			
Natural air cooling			Natural air cooling			
303.8×231.0×54.0		235.0×180.0×48.9		303.8×231.0×54.0		235.0×180.0×48.9
289.0×216.2(+0.5/-0)		220.5×165.5(+0.5/-0)		289.0×216.2(+0.5/-0)		220.5×165.5(+0.5/-0)
Light gray			Light gray			
PC			PC			

Performance Specifications

Item	V9 Advanced		V9 Standard	
	V9101iW	V9071iW	V9150iX	V9120iS
Screen memory (FROM)	64MB			
Backup memory (SRAM)	800KB			
Display	Display device		TFT color LCD	
	Resolution		1024×600	
	Display size		10.1" Wide	
	Colors		16.7 million ^{*2}	
	Backlight		LED	
Touch switch	Type		Capacitance	
	Quantity		None	
Function switch	Type		Analog resistance film	
	Quantity		8	
External interface	D-Sub 9-pin (CN1) ^{*3}		RS-232C/ RS-422/485, Asynchronous type, Data length: 7,8 bits, Parity: even, odd, none, Stop bit: 1, 2 bits, Baud rate: 4800, 9600, 19200, 38400, 57600, 76800, 115200,187500*bps	
	Modular 8-pin (MJ1/ MJ2)		RS-232C/ RS-422/ RS-485 (two-wire system), ^{*3} Asynchronous type, Data length: 7,8 bits, Parity: even, odd, none, Stop bit: 1, 2 bits, Baud rate: 4800, 9600, 19200, 38400, 57600, 76800, 115200 bps	
	SD card		One card slot provided as standard	
	Ethernet		2ch, Baud rate: 100Mbps, 10Mbps	
	Wireless LAN		Complies with IEEE802.11b/g/n (2.4GHz) ^{*5}	
	USB		Type A, Type mini-B (Ver.2.0)	
Clock	Sound output		1ch provided as standard	
	Backup period		5 years (Ambient temperature 25°C)	
Standard	Calendar accuracy		Gap ±90 sec. per month (Ambient temperature 25°C, When the battery is backed up)	
	CE marking ^{*7}		EN61000-6-2, EN61000-6-4	
	UL-cUL ^{*7}		UL508	
	KC		Compliant	
Radio Act ^{*6}		Japan: TELEC, USA: FCC, Canada: IC RSS		

*2: Only for pictures, 3D parts and videos. Other items are displayed in 65,536 colors. *3: Optional unit (DUR-00) is required for the V9071iW and V9060iTD. *4: Only for Siemens MPI (Incompatible with DUR-00). *5: 187,500bps (four-wire system) for the V9071iW and V9060iTD MJ2 only. *6: Wireless LAN-compatible products only. *7: DC products only.

V9 Standard		V9 Lite		
V9100iS	V9080iSD	V9100iC	V9080iCD	V9060iTD
64MB		64MB		
800KB		800KB		
TFT color LCD		TFT color LCD		
800×600		640×480		
10.4"		8.4"		
16.7 million ^{*2}		260,000 ^{*2}		
LED		LED		
70,000 hours		50,000 hours		
Analog resistance film		Analog resistance film		
8		6		
RS-232C/ RS-422/485, Asynchronous type, Data length: 7,8 bits, Parity: even, odd, none, Stop bit: 1, 2 bits, Baud rate: 4800, 9600, 19200, 38400, 57600, 76800, 115200,187500*bps		RS-232C/ RS-422/485, Asynchronous type, Data length: 7,8 bits, Parity: even, odd, none, Stop bit: 1, 2 bits, Baud rate: 4800, 9600, 19200, 38400, 57600, 76800, 115200,187500*bps		
RS-232C/ RS-422/ RS-485 (two-wire system), ^{*5} Asynchronous type, Data length: 7,8 bits, Parity: even, odd, none, Stop bit: 1, 2 bits, Baud rate: 4800, 9600, 19200, 38400, 57600, 76800, 115200 bps		RS-232C/ RS-422/ RS-485 (two-wire system), ^{*5} Asynchronous type, Data length: 7,8 bits, Parity: even, odd, none, Stop bit: 1, 2 bits, Baud rate: 4800, 9600, 19200, 38400, 57600, 76800, 115200 bps		
One card slot provided as standard		One card slot provided as standard		
1ch, Baud rate: 100Mbps, 10Mbps		1ch, Baud rate: 100Mbps, 10Mbps		
-		-		
Type A, Type mini-B (Ver.2.0)		Type A, Type mini-B (Ver.2.0)		
1ch provided as standard		-		
5 years (Ambient temperature 25°C)		5 years (Ambient temperature 25°C)		
Gap ±90 sec. per month (Ambient temperature 25°C, When the battery is backed up)		Gap ±90 sec. per month (Ambient temperature 25°C, When the battery is backed up)		
EN61000-6-2, EN61000-6-4		EN61000-6-2, EN61000-6-4		
UL508		UL508		
Compliant		Compliant		
-		-		

Flexible system configuration meets diversified requirements.

Advanced Model System Configuration

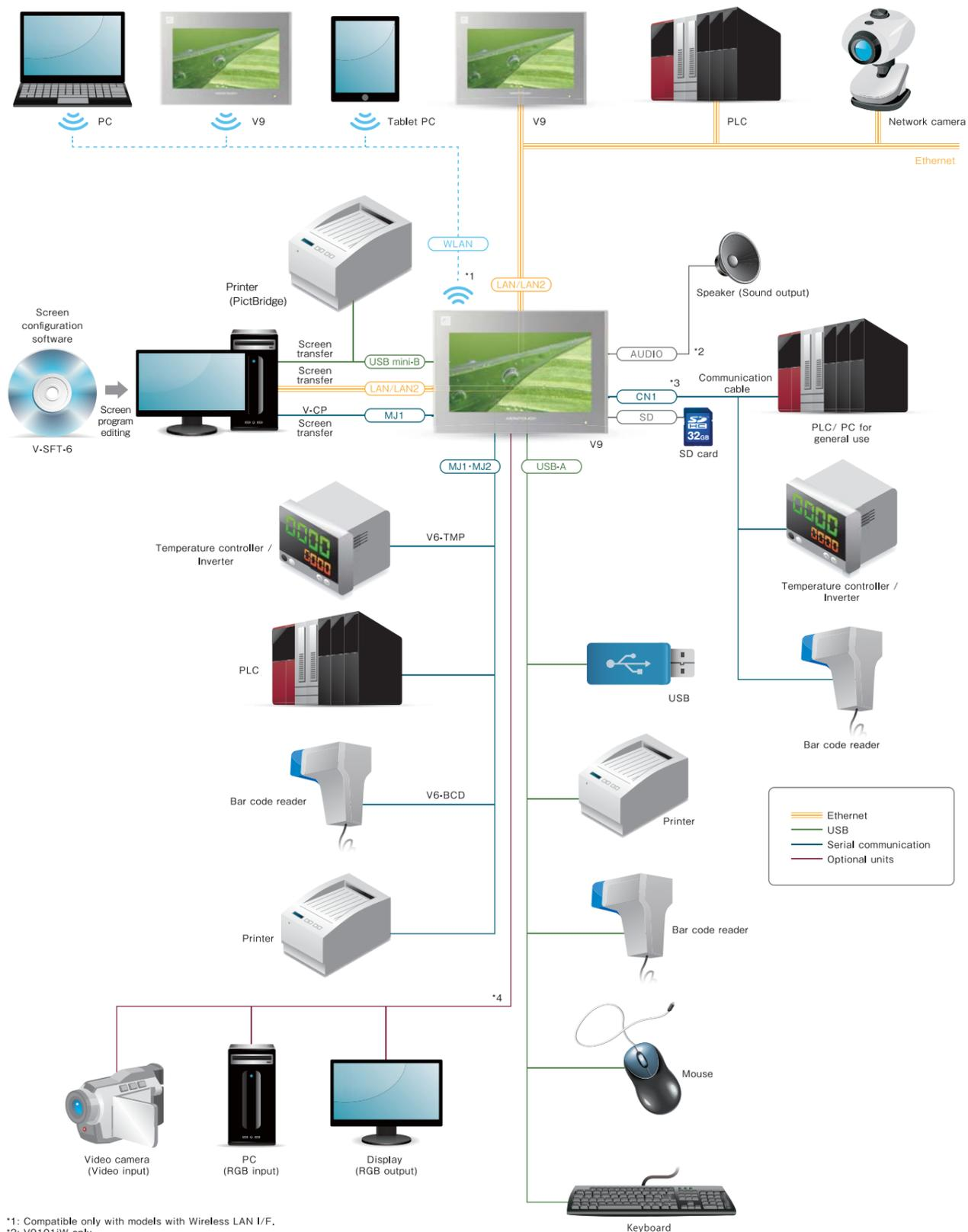

*1: Compatible only with models with Wireless LAN I/F.
 *2: V9101iW only
 *3: Optional unit DUR-00 is required when using the V9071iW.
 *4: V9101iW only. Optional unit GUR-XX is required.

Standard Model System Configuration

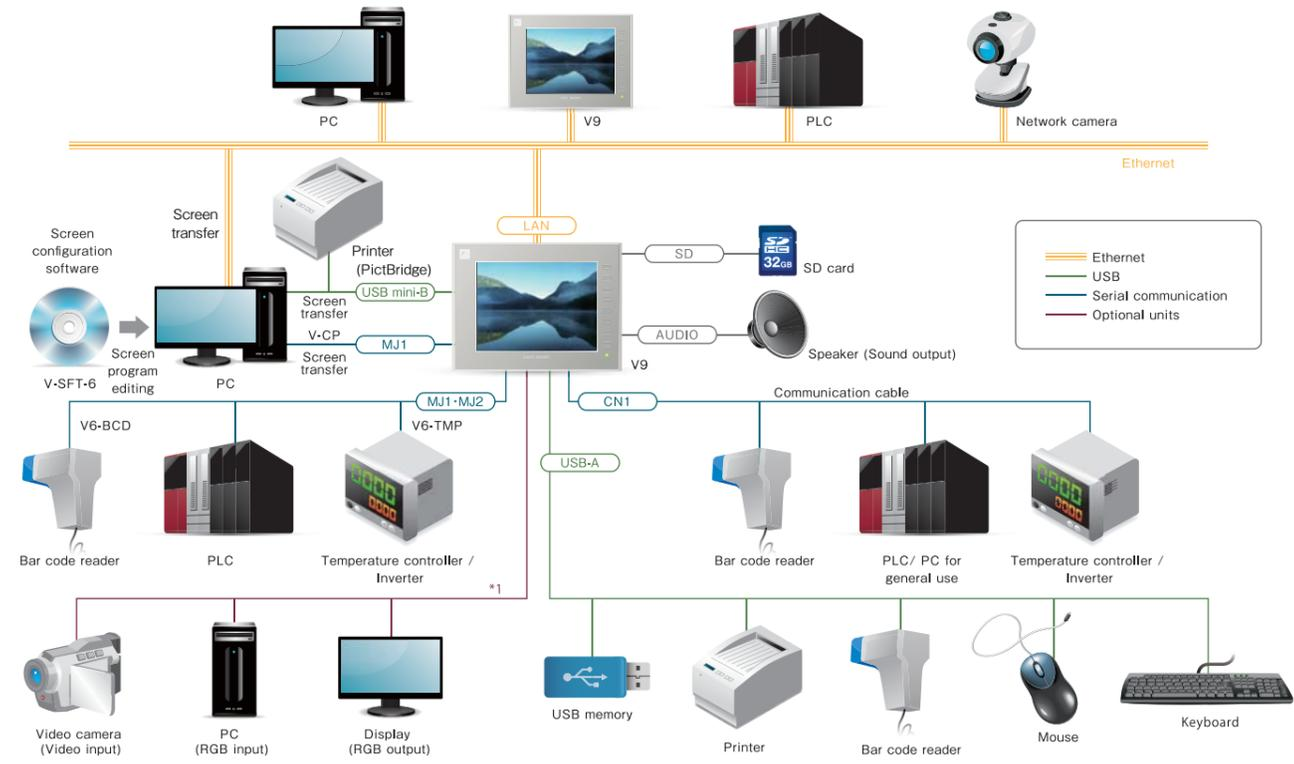

*1 The optional unit (GUR-xx) is required.

Lite Model System Configuration

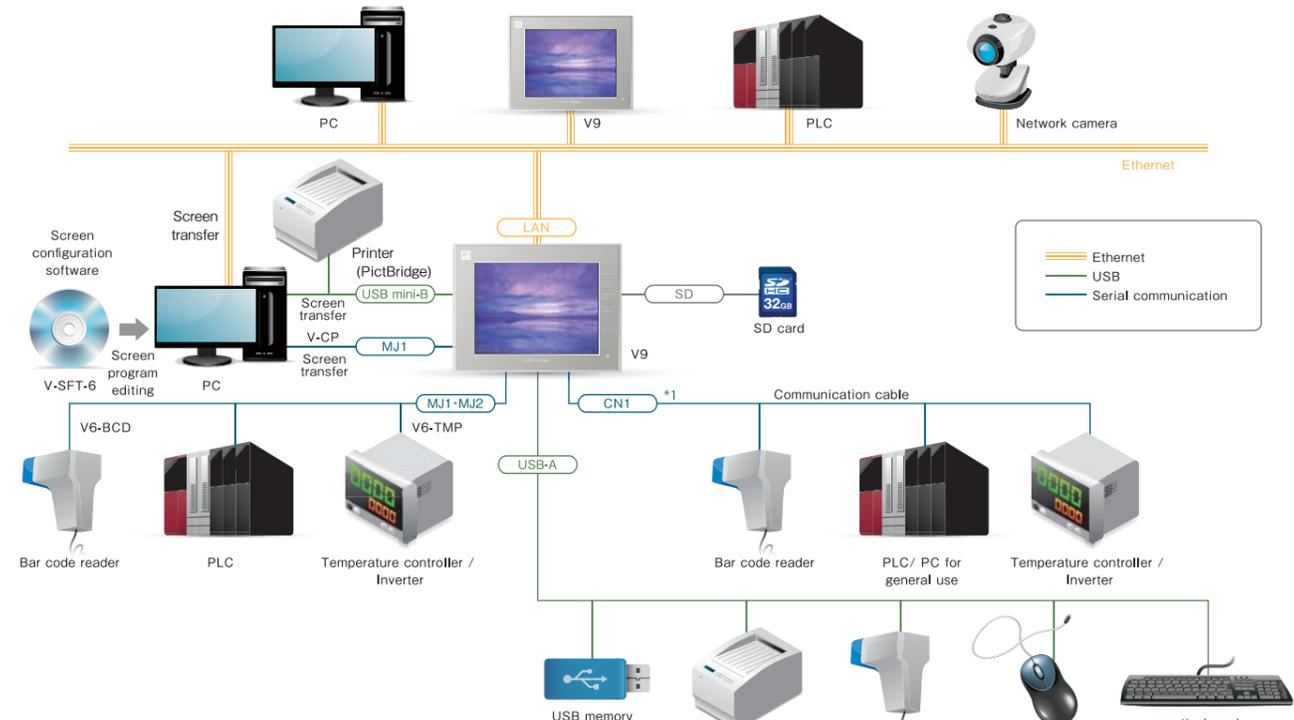

*1 The optional unit (DUR-00) is required for V9060iTD.

Dimensions and Part Names

V9 Advanced V9101iW (Unit: mm)

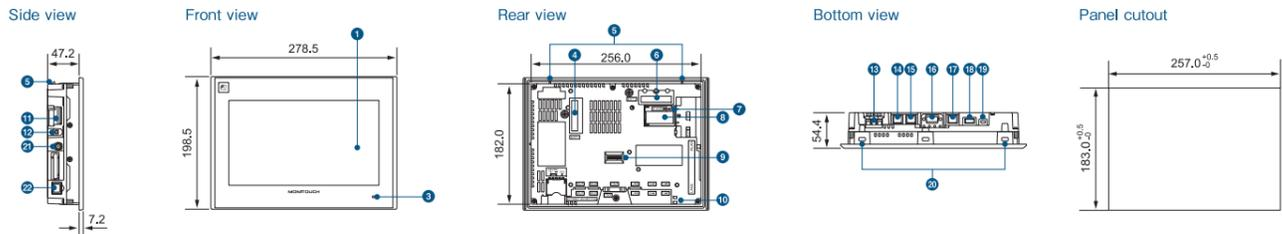

V9 Advanced V9071iW (Unit: mm)

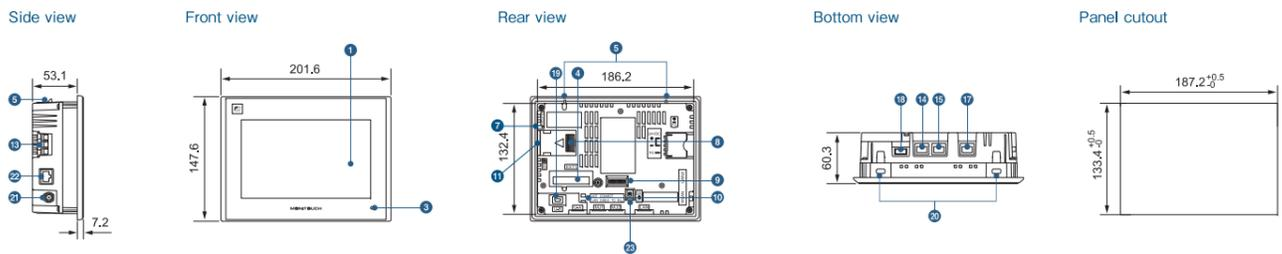

V9 Standard V9150iX (Unit: mm)

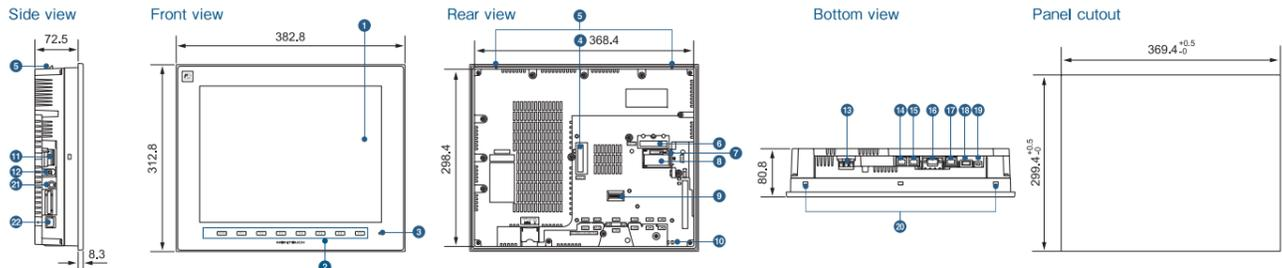

V9 Standard V9120iS (Unit: mm)

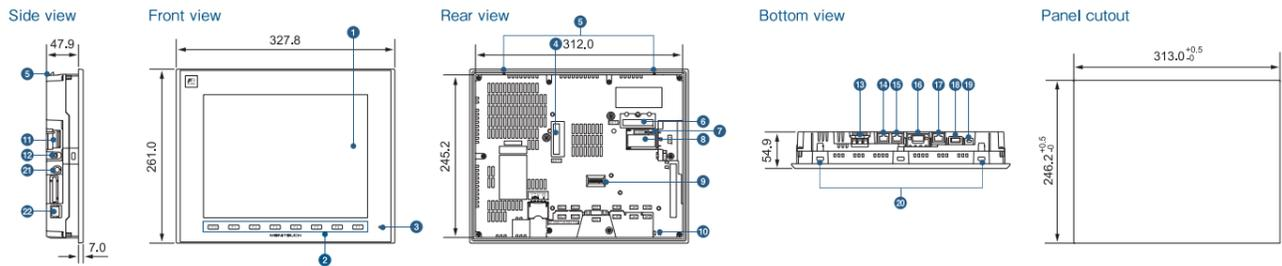

V9 Standard V9100iS (Unit: mm)

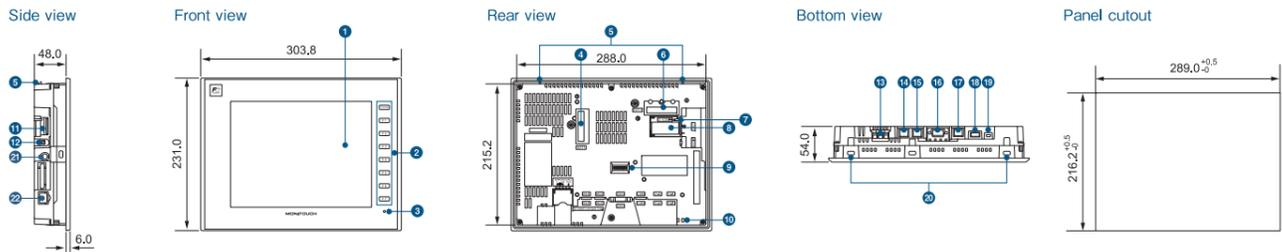

V9 Standard V9080iSD (Unit: mm)

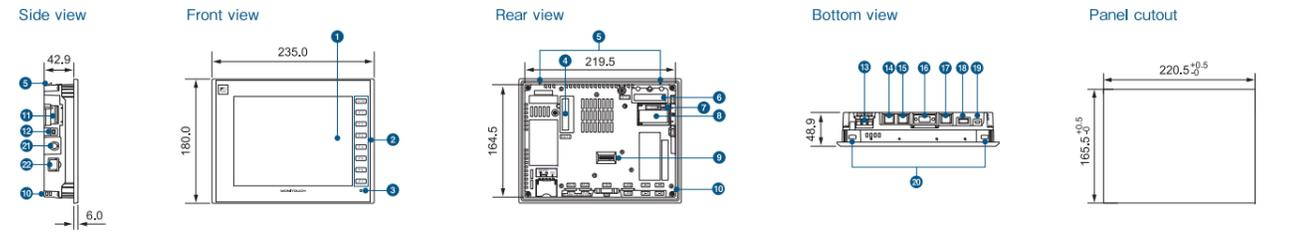

V9 Lite V9100iC (Unit: mm)

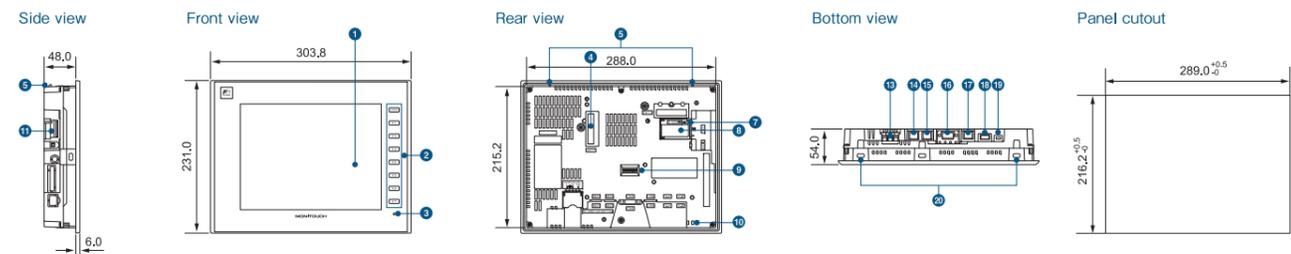

V9 Lite V9080iCD (Unit: mm)

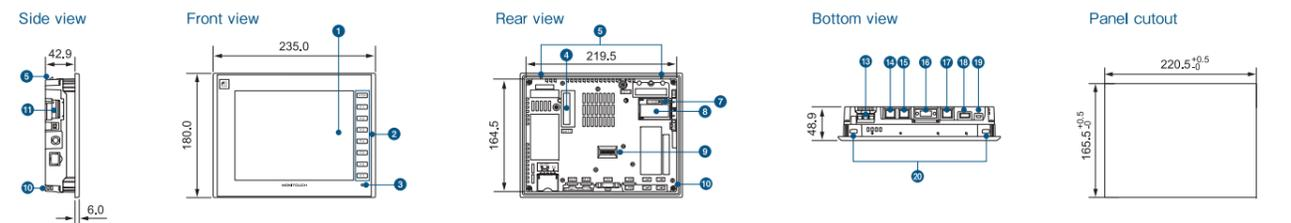

V9 Lite V9060iTD (Unit: mm)

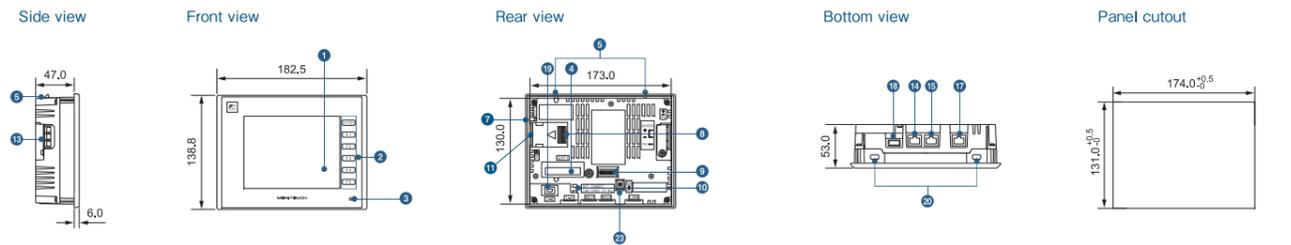

Part Names

- | | | | |
|---------------------------------------|-----------------------------------|-----------------------------------|---|
| 1 Display | 7 SD card access LED | 13 Power input terminal block | 19 USB mini-B (U-B) |
| 2 Function switch | 8 Battery holder | 14 Modular jack 1 (MJ1) | 20 Screw hole |
| 3 Power lamp | 9 DIP switch | 15 Modular jack 2 (MJ2) | 21 Wireless LAN external antenna connector (WLAN) |
| 4 Communication unit connector (EXT1) | 10 USB cable holding hole | 16 PLC connector (CN1) | 22 100BASE-TX/10BASE-T port (LAN2) |
| 5 Fall prevention hook | 11 SD card connector | 17 100BASE-TX/10BASE-T port (LAN) | 23 Slide switch |
| 6 Optional unit connector (EXT2) | 12 Sound output connector (AUDIO) | 18 USB-A (U-A) | |

Remarkable cost effectiveness enabled by

our product lineup and optional units.

Product List

Advanced

Model	Display Size	Resolution	Specification									Delivery Standard: ✓ Made to order: △
			Touch Switch	Video/RGB	AUDIO Output	Wireless LAN	Extended Cable LAN	UL508	CE	KC	Power	
V9101IWRLD	10.1" Wide	1024×600	Capacitance	✓	✓	✓	✓	✓	✓	✓	DC	✓
V9100IWRLD			Analog resistance film	✓	✓	✓	✓	✓	✓	✓		△
V9101IWLD			Capacitance	✓	✓	—	✓	✓	✓	✓		✓
V9100IWLD			Analog resistance film	✓	✓	—	✓	✓	✓	✓		△
V9071IWRLD	7" Wide	800×480	Capacitance	—	—	✓	✓	✓	✓	✓	DC	✓
V9070IWRLD*			Analog resistance film	—	—	✓	✓	✓	✓	✓		△
V9071IWLD			Capacitance	—	—	—	✓	✓	✓	✓		✓
V9070IWLD*			Analog resistance film	—	—	—	✓	✓	✓	✓	△	

Standard

Model	Display Size	Resolution	Specification									Delivery Standard: ✓ Made to order: △	
			Touch Switch	Video/RGB	AUDIO Output	Wireless LAN	Extended Cable LAN	UL508	CE	KC	Power		
V9150IX*	15"	1024×768	Analog resistance film	✓	✓	—	—	—	—	✓	AC	✓	
V9150IXD*			Analog resistance film	✓	✓	—	—	✓	✓	✓		DC	✓
V9150IXLD*			Analog resistance film	✓	✓	—	✓	✓	✓	✓			△
V9150IXRD*			Analog resistance film	✓	✓	✓ ²	—	✓	—	—		—	△
V9120IS	12.1"	800×600	Analog resistance film	✓	✓	—	—	—	—	✓	AC	✓	
V9120ISD			Analog resistance film	✓	✓	—	—	✓	✓	✓		DC	✓
V9120ISLD			Analog resistance film	✓	✓	—	✓	✓	✓	✓			△
V9120ISRD			Analog resistance film	✓	✓	✓ ²	—	✓	—	—		—	△
V9100IS	10.4"	800×600	Analog resistance film	✓	✓	—	—	—	—	—	AC	✓	
V9100ISD			Analog resistance film	✓	✓	—	—	✓	✓	✓		DC	✓
V9100ISLD			Analog resistance film	✓	✓	—	✓	✓	✓	✓			△
V9100ISRD			Analog resistance film	✓	✓	✓ ²	—	✓	—	—		—	△
V9080ISD	8.4"	800×600	Analog resistance film	✓	✓	—	—	✓	✓	✓	DC	✓	
V9080ISLD			Analog resistance film	✓	✓	—	✓	✓	✓	✓		△	
V9080ISRD			Analog resistance film	✓	✓	✓ ²	—	✓	—	—		△	

Lite

Model	Display Size	Resolution	Specification									Delivery Standard: ✓ Made to order: △
			Touch Switch	Video/RGB	AUDIO Output	Wireless LAN	Extended Cable LAN	UL508	CE	KC	Power	
V9100IC	10.4"	640×480	Analog resistance film	—	—	—	—	—	—	✓	AC	✓
V9100ICD			Analog resistance film	—	—	—	—	✓	✓	✓		DC
V9080ICD	8.4"	640×480	Analog resistance film	—	—	—	—	✓	✓	✓	DC	
V9060ITD*	5.7"	640×480	Analog resistance film	—	—	—	—	✓	✓	✓	DC	✓

*1: Scheduled for April 2015 release.

*2: Only for use in Japan.

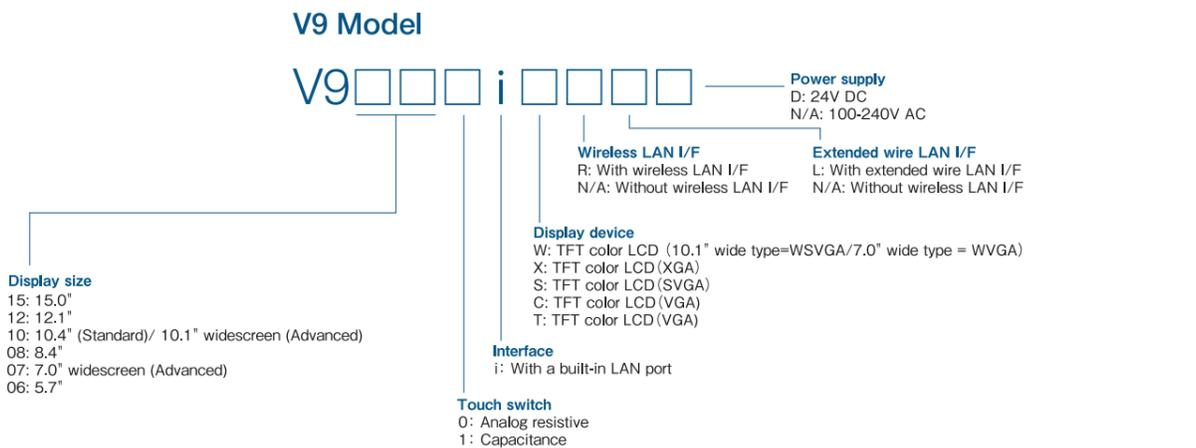

Optional Unit List

Type	Product	Compatible Model								
		Advanced		Standard			Lite			
		V9101IW	V9071IW	V9150IX	V9120IS	V9100IS	V9080IS	V9100IC	V9080IC	V9060IT
Configuration Software										
V-SFT-6	V8/V9 design tool software Ver.6 (Manual not included)	✓	✓	✓	✓	✓	✓	✓	✓	✓
Extension Units										
GUR-00 ¹⁾	Video 4ch input	✓		✓	✓	✓	✓			
GUR-01	RGB 1ch input	✓		✓	✓	✓	✓			
GUR-02	RGB 1ch output	✓		✓	✓	✓	✓			
GUR-04	Video 1ch input	✓		✓	✓	✓	✓			
GUR-10 ¹⁾	Video 2ch input/ RGB 1ch input	✓		✓	✓	✓	✓			
GUR-11 ¹⁾	RGB 2ch input	✓		✓	✓	✓	✓			
DUR-00	V9071IW/ V9060ITD optional unit		✓							✓
Communication Units										
CUR-00	OPCN-1	✓	✓	✓	✓	✓	✓	✓	✓	✓
CUR-01	T-link	✓	✓	✓	✓	✓	✓	✓	✓	✓
CUR-02	CC-Link	✓	✓	✓	✓	✓	✓	✓	✓	✓
CUR-03	Ethernet	✓	✓	✓	✓	✓	✓	✓	✓	✓
CUR-04	PROFIBUS-DP	✓	✓	✓	✓	✓	✓	✓	✓	✓
CUR-06	SX bus	✓	✓	✓	✓	✓	✓	✓	✓	✓
CUR-07	DeviceNet	✓	✓	✓	✓	✓	✓	✓	✓	✓
CUR-08	FL-net	✓	✓	✓	✓	✓	✓	✓	✓	✓
Cables										
V-CP	Screen transfer cable (3m)	✓	✓	✓	✓	✓	✓	✓	✓	✓
UA-FR	USB-A extension cable (1m)	✓	✓	✓	✓	✓	✓	✓	✓	✓
V6-MLT	Multi-link 2 master cable (3m)	✓	✓	✓	✓	✓	✓	✓	✓	✓
V6-TMP	Temperature controller cable (3m)	✓	✓	✓	✓	✓	✓	✓	✓	✓
V6-TMP-5M	Temperature controller cable (5m)	✓	✓	✓	✓	✓	✓	✓	✓	✓
V6-TMP-10M	Temperature controller cable (10m)	✓	✓	✓	✓	✓	✓	✓	✓	✓
V6-BCD	Bar code reader cable (3m)	✓	✓	✓	✓	✓	✓	✓	✓	✓
D9-MB-CPUQ-2M	MITSUBISHI ELECTRIC A series / QnA series CPU (Dsub25) RS-422	✓	△ ²	✓	✓	✓	✓	✓	✓	△ ²
D9-MB-CPUQ-3M		✓	△ ²	✓	✓	✓	✓	✓	✓	△ ²
D9-MB-CPUQ-5M		✓	△ ²	✓	✓	✓	✓	✓	✓	△ ²
D9-MB-CPUQ-10M		✓	△ ²	✓	✓	✓	✓	✓	✓	△ ²
D9-MB-CPUQ-15M		✓	△ ²	✓	✓	✓	✓	✓	✓	△ ²
D9-QCPU2-2M	MITSUBISHI ELECTRIC Q series CPU (Mini DIN6) RS-232C	✓	△ ²	✓	✓	✓	✓	✓	✓	△ ²
D9-QCPU2-3M		✓	△ ²	✓	✓	✓	✓	✓	✓	△ ²
D9-QCPU2-5M		✓	△ ²	✓	✓	✓	✓	✓	✓	△ ²
D9-QCPU2-10M		✓	△ ²	✓	✓	✓	✓	✓	✓	△ ²
D9-QCPU2-15M		✓	△ ²	✓	✓	✓	✓	✓	✓	△ ²
D9-MI2-09-2M	MITSUBISHI ELECTRIC link unit (Dsub9) RS-232C	✓	△ ²	✓	✓	✓	✓	✓	✓	△ ²
D9-MI2-09-3M		✓	△ ²	✓	✓	✓	✓	✓	✓	△ ²
D9-MI2-09-5M		✓	△ ²	✓	✓	✓	✓	✓	✓	△ ²
D9-MI2-09-10M		✓	△ ²	✓	✓	✓	✓	✓	✓	△ ²
D9-MI2-09-15M		✓	△ ²	✓	✓	✓	✓	✓	✓	△ ²
D9-MI4-FX-2M	MITSUBISHI ELECTRIC FX series CPU (Mini DIN8) RS-422	✓	△ ²	✓	✓	✓	✓	✓	✓	△ ²
D9-MI4-FX-3M		✓	△ ²	✓	✓	✓	✓	✓	✓	△ ²
D9-MI4-FX-5M		✓	△ ²	✓	✓	✓	✓	✓	✓	△ ²
D9-MI4-FX-10M		✓	△ ²	✓	✓	✓	✓	✓	✓	△ ²
D9-MI4-FX-15M		✓	△ ²	✓	✓	✓	✓	✓	✓	△ ²
D9-FU-SPHCPU-2M	FUJI ELECTRIC SPH CPU RS-485 (4-wire)	✓	△ ²	✓	✓	✓	✓	✓	✓	△ ²
D9-FU-SPHCPU-3M		✓	△ ²	✓	✓	✓	✓	✓	✓	△ ²
D9-FU-SPHCPU-5M		✓	△ ²	✓	✓	✓	✓	✓	✓	△ ²
D9-FU-SPBCPU-2M		✓	△ ²	✓	✓	✓	✓	✓	✓	△ ²
D9-FU-SPBCPU-3M		✓	△ ²	✓	✓	✓	✓	✓	✓	△ ²
D9-FU-SPBCPU-5M	✓	△ ²	✓	✓	✓	✓	✓	✓	△ ²	
D9-D25	Dsub9-Dsub25 conversion cable (0.3m)	✓	△ ²	✓	✓	✓	✓	✓	✓	△ ²
Communication Terminal Block										
TC-D9	Terminal converter for V9/V8	✓	△ ²	✓	✓	✓	✓	✓	✓	△ ²
Battery										
V9-BT	Replacement battery for V9	✓		✓	✓	✓	✓	✓	✓	
V7-BT	Replacement battery for V9071IW/V9060ITD/V8		✓							✓
Wireless LAN Antenna										
V9-ANT	V9 external antenna with cable (3m)	✓	✓							
Protection Sheets										
V715-GS	V9150IX/V815/V715 protection sheets			✓						
V715-GSN10	V9150IX/V815/V715 protection sheets (Non-glare)			✓						
V912S-GS	V9120IS protection sheets				✓					
V912S-GSN10	V9120IS protection sheets (Non-glare)				✓					
V910S-GS	V9100IS/V9100IC protection sheets					✓				
V910S-GSN10	V9100IS/V9100IC protection sheets (Non-glare)					✓				
V908S-GS	V9080IS/V9080IC protection sheets						✓			
V908S-GSN10	V9080IS/V9080IC protection sheets (Non-glare)						✓			
V906T-GS	V9060ITD protection sheets									✓
V906T-GSN10	V9060ITD protection sheets (Non-glare)									✓

*1 : Scheduled to be developed.

*2 : The optional unit (DUR-00) is required.

V8 Series – scaling new heights in performance, usability and connectivity.

MONITOUCH V8 series

Provided with revolutionary features for production sites such as 8-way communication and 16-million-color high-resolution video display, the V8 series has expanded the potential of programmable operator interface panels. The screen programs and panels of the V7 series are also compatible with the V8 series.

Product Lineup

High performance model

15.0 inches	12.1 inches	10.4 inches	8.4 inches
			
V815IX	V812IS V812S	V810IS V810S	V810IT V810T
			V808ISD V808SD

Standard model

10.4 inches	8.4 inches	7.7 inches	5.7 inches
			
V810iC V810C	V808iCD V808CD	V808iCHx V808CHx	V806iTD V806TD
			V806iCD V806CD
			V806iMD V806MD

V8 Model

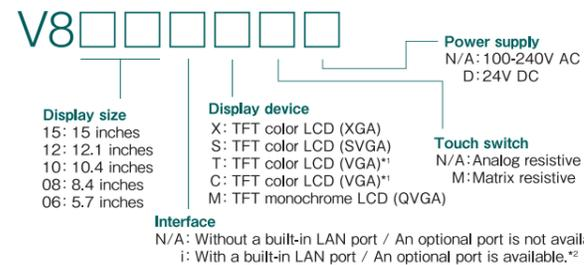

V808CH Model

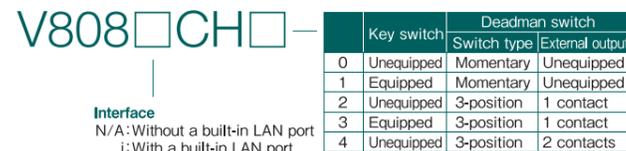

Specifications

Item	V815IX	V812IS	V812S	V810IS	V810S	V810IT	V810T	V810IC	V810C	V808ISD	V808SD	V808ICD	V808CD	
Basic specification														
Display size	15 inches	12.1 inches	10.4 inches						8.4 inches					
Display device	TFT color LCD													
Resolution W:H (dots)	1024×768	800×600				640×480				800×600		640×480		
Colors	65,536 colors (without blinks) / 32,768 colors (with blinks)													
Screen memory	FROM (12.5MB)								FROM (4.5MB)	FROM (12.5MB)			FROM (4.5MB)	
Backup memory	SRAM (512KB)								SRAM (128KB)	SRAM (512KB)			SRAM (128KB)	
D-Sub 9-pin CN1	RS-232C, RS-422/485, Asynchronous, Data length: 7.8 bits, Parity: even, odd, none, Stop bit: 1.2 bits, Baud rate: 4800, 9600, 19200, 38400, 57600, 76800, 115200, 187500** bps													
Modular 8-pin MJ1/MJ2	RS-232C, RS-422/485 (two-wire system), Asynchronous, Data length: 7.8 bits, Parity: even, odd, none, Stop bit: 1.2 bits, Baud rate: 4800, 9600, 19200, 38400, 57600, 76800, 115200 bps													
Interface														
Ethernet	100BASE-TX/10BASE-T Built-in	Option (CU-03-3)		100BASE-TX/10BASE-T Built-in	Option (CU-03-3)		100BASE-TX/10BASE-T Built-in	Option (CU-03-3)		100BASE-TX/10BASE-T Built-in	Option (CU-03-3)		100BASE-TX/10BASE-T Built-in	
Communication I/F	Equipped													
Expansion I/F	Equipped	-		Equipped	-		Equipped	-		Equipped	-			
CF card I/F	Equipped													
USB I/F	Type A and B (Ver1.1)													
Video (4ch)	GU-00	-		GU-00	-		GU-00	-		GU-00	-			
RGB input	GU-01	-		GU-01	-		GU-01	-		GU-01	-			
RGB output	GU-02	-		GU-02	-		GU-02	-		GU-02	-			
Video (2ch)+RGB input	GU-10	-		GU-10	-		GU-10	-		GU-10	-			
RGB input (2ch)	GU-11	-		GU-11	-		GU-11	-		GU-11	-			
Sound output	GU-00~03	-		GU-00~03	-		GU-00~03	-		GU-00~03	-			
Communication unit	CU-00, CU-01, CU-02-2, CU-03-3, CU-04, CU-06, CU-07, CU-08													
I/O unit	V-I/O													
CE Marking*2	EN61000-6-2, EN61000-6-4													
UL-cUL*7	UL508/UL1604*4													
Marine Standards*3	NK,LR, DNV,ABS, BV,CCS	NK, BV, CCS				NK, LR, DNV, ABS, BV, CCS, GL				-		NK, LR, DNV, ABS, BV, CCS, GL		
RoHS directive	Complied													

Item	V806iTD	V806TD	V806iCD	V806CD	V806iMD	V806MD
Basic specification						
Display size	5.7 inches					
Display device	TFT color LCD			TFT monochrome LCD		
Resolution W:H (dots)	320×240					
Colors	65,536 colors (without blinks)			32,768 colors (with blinks)		16 grayscale (with blinks)
Screen memory	FROM (4.5MB)					
Backup memory	SRAM (512KB)	SRAM (128KB)	SRAM (512KB)	SRAM (128KB)	SRAM (512KB)	SRAM (128KB)
D-Sub 9-pin CN1*	RS-232C, RS-422/485, Asynchronous, Data length: 7.8 bits, Parity: even, odd, none, Stop bit: 1.2 bits, Baud rate: 4800, 9600, 19200, 38400, 57600, 76800, 115200 bps					
Modular 8-pin MJ1/MJ2*	RS-232C, RS-422/485 (two-wire system), Asynchronous, Data length: 7.8 bits, Parity: even, odd, none, Stop bit: 1.2 bits, Baud rate: 4800, 9600, 19200, 38400, 57600, 76800, 115200, 187500** bps					
Interface						
Ethernet	100BASE-TX/10BASE-T Built-in	Option (CU-03-3)	100BASE-TX/10BASE-T Built-in	Option (CU-03-3)	100BASE-TX/10BASE-T Built-in	Option (CU-03-3)
Communication I/F	Equipped					
Extension I/F	-					
CF card I/F	Equipped*					
USB I/F	Type A and B (Ver1.1)					
Video (4ch)	-					
RGB input	-					
RGB output	-					
Video (2ch)+RGB input	-					
RGB input (2ch)	-					
Sound output	-					
Communication unit	CU-00, CU-01, CU-02-2, CU-03-3, CU-04, CU-06, CU-07, CU-08					
I/O unit	V-I/O					
CE Marking	EN61000-6-2, EN61000-6-4					
UL-cUL	UL508/UL1604*4					
Marine Standards*3	NK, LR, DNV, ABS, BV, CCS, GL					
RoHS directive	Complied					

Item	V808iCHx	V808CHx
Basic specification		
Display size	7.5 inches	
Display device	TFT color LCD	
Resolution W:H (dots)	640×480	
Colors	65,536 colors (without blinks) / 32,768 colors (with blinks)	
Screen memory	FROM (12.5MB)	FROM (4.5MB)
Backup memory	SRAM (512KB)	SRAM (128KB)
D-Sub 9-pin CN1*	RS-232C, Asynchronous, Data length: 7.8 bits, Parity: even, odd, none, Stop bit: 1.2 bits, Baud rate: 4800, 9600, 19200, 38400, 57600, 76800, 115200 bps	
Modular 8-pin MJ1/MJ2*	RS-422/485, Asynchronous, Data length: 7.8 bits, Parity: even, odd, none, Stop bit: 1.2 bits, Baud rate: 4800, 9600, 19200, 38400, 57600, 76800, 115200, 187500** bps	
Interface		
TB2	100BASE-TX/10BASE-T	
TB3	Not equipped	
Ethernet	100BASE-TX/10BASE-T	
CF card I/F	Equipped	
USB I/F	Type B (Ver1.1)	
No. of switches	12 (4: For external output)	
Switch type	Membrane switch	
Mechanical life	One million times or more	
Switch type	Push lock type (b-contact, 2 circuits)	
Mechanical life	100,000 times or more	
Rated voltage	24V DC	
Rated current	1A (load resistance)	
Contact point	a-contact, 1 circuit	
Mechanical life	250,000 times or more	
Electrical life	100,000 times or more (Switching frequency: 1,200 times/h)	
Function specification		
Emergency stop switch specification		
Key switch specification		
Deadman switch specification		
3-position	Switch type	3-position output (a-contact, 2 circuits**)
	Mechanical life	Off-On: One million times or more, OFF-ON-OFF (direct circuit): 100 thousand times
	Rated voltage	24V DC
	Rated current	1A (load resistance)
Momentary	Switch type	Momentary switch
	Mechanical life	One million times or more
Compatibility		
CE Marking	EN61000-6-2, EN61000-6-4	
UL-cUL	UL508*7	
RoHS directive	Complied	

*1: QVGA for V806.
*2: No optional port for V810iC, V808iC or V806i.

*1: Only when connected with SIEMENS MPI/PP1. *2: Only with 24V DC models. *3: Please contact us for a unit that complies with the marine standards.
*4: Please contact us for a unit that complies with UL1604. *5: Only when connected with SIEMENS MPI/PP1 (MJ2 only). Not available for D-Sub9 pin (option).
*6: Only when equipped with DU-10 (option). *7: Please contact our sales department for a unit that complies with UL508. *8: MJ2 is compatible with RS-422 (4-wire).
*9: a-contact: 2 circuits for CH4 and 1 circuit for CH2 and CH3 of V808(i).

Wide range of products and optional units

for expanding performance.

Dimensions and Part Names

V815iX / V815iXD (Unit:mm)

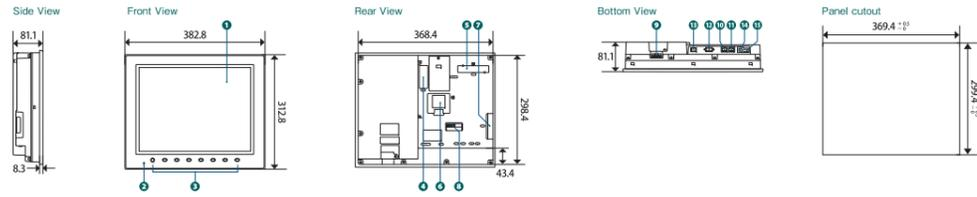

V812iS / V812S (Unit:mm)

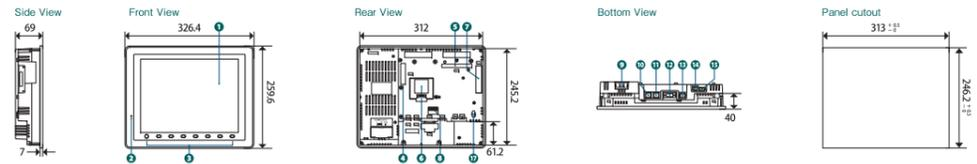

V810iS / V810S / V810iT / V810T / V810iC / V810C (Unit:mm)

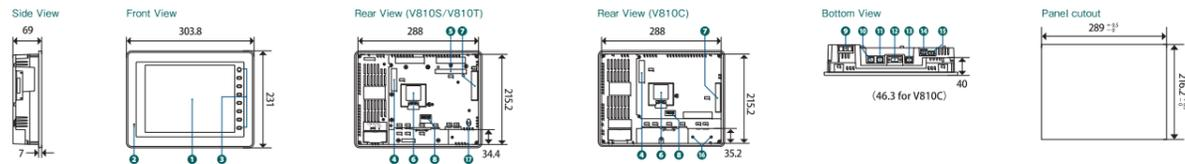

V808iS / V808S / V808iC / V808C (Unit:mm)

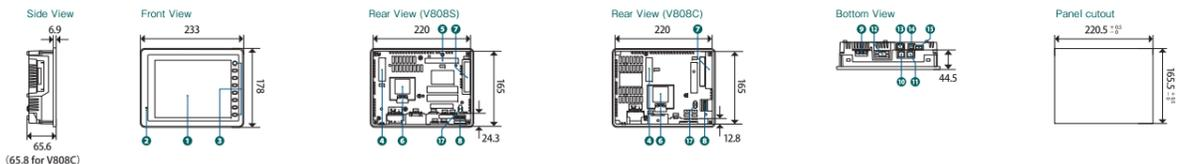

V806iT / V806T / V806iC / V806C / V806iM / V806M (Unit:mm)

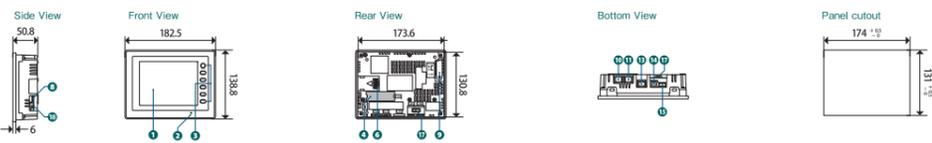

V808iCH / V808CH (Unit:mm)

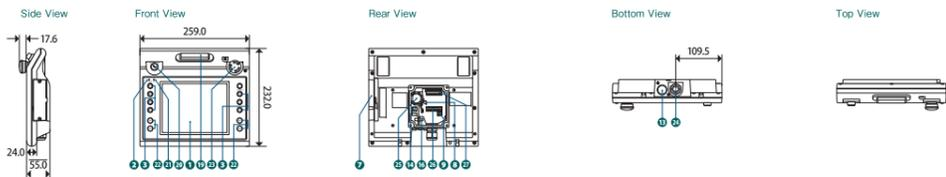

Part Names

- 1 Display
- 2 Power lamp
- 3 Function switch
- 4 Connector for communication unit (CN5)
- 5 Connector for optional unit (CN7)
- 6 Battery holder
- 7 CF card slot (CF)
- 8 DIP switch
- 9 Power supply (TB1)
- 10 Modular 8-pin for serial port (MJ1)
- 11 Modular 8-pin for serial port (MJ2)
- 12 D-sub9 pin for serial port (CN1)
- 13 100BASE-TX/10BASE-T port (LAN)
- 14 USB-B (U-B)
- 15 USB-A (U-A)
- 16 Screw hole for fixing USB cable lock
- 17 Inlet port for fixing USB cable
- 18 Slide switch
- 19 Deadman switch
- 20 Key switch
- 21 Operation lamp
- 22 External output switch
- 23 Emergency stop switch
- 24 Cable insertion port
- 25 Battery
- 26 Terminal block (TB2)
- 27 Terminal block (TB3)

Optional Unit List

Type	Product	Compatible Model																				
		V815		V812		V810				V808				V806								
		iX	iS	S	iS	S	IT	T	IC	C	iS	S	IC	C	ICH	CH	IT	T	IC	C	IM	M
Configuration Software																						
V-SFT-5(CD)	Configuration Software for V8 - V4 series (without the manual) Ver.5	✓	✓	✓	✓	✓	✓	✓	✓	✓	✓	✓	✓	✓	✓	✓	✓	✓	✓	✓	✓	✓
Communication Units																						
CU-00	OPCN-1	✓	✓	✓	✓	✓	✓	✓	✓	✓	✓	✓	✓	✓	✓	✓	✓	✓	✓	✓	✓	✓
CU-01	T-Link	✓	✓	✓	✓	✓	✓	✓	✓	✓	✓	✓	✓	✓	✓	✓	✓	✓	✓	✓	✓	✓
CU-02-2	CC-Link	✓	✓	✓	✓	✓	✓	✓	✓	✓	✓	✓	✓	✓	✓	✓	✓	✓	✓	✓	✓	✓
CU-03-3	Ethernet	✓	✓	✓	✓	✓	✓	✓	✓	✓	✓	✓	✓	✓	✓	✓	✓	✓	✓	✓	✓	✓
CU-04	PROFIBUS-DP	✓	✓	✓	✓	✓	✓	✓	✓	✓	✓	✓	✓	✓	✓	✓	✓	✓	✓	✓	✓	✓
CU-06	SX bus	✓	✓	✓	✓	✓	✓	✓	✓	✓	✓	✓	✓	✓	✓	✓	✓	✓	✓	✓	✓	✓
CU-07	Device Net	✓	✓	✓	✓	✓	✓	✓	✓	✓	✓	✓	✓	✓	✓	✓	✓	✓	✓	✓	✓	✓
CU-08	FL-net Ver.2(OPCN-2)	✓	✓	✓	✓	✓	✓	✓	✓	✓	✓	✓	✓	✓	✓	✓	✓	✓	✓	✓	✓	✓
Optional units																						
GU-00	Video 4ch input/ Sound output	✓	✓	✓	✓	✓	✓	✓	✓	✓	✓	✓	✓	✓	✓	✓	✓	✓	✓	✓	✓	✓
GU-01	RGB 1ch input/ Sound output	✓	✓	✓	✓	✓	✓	✓	✓	✓	✓	✓	✓	✓	✓	✓	✓	✓	✓	✓	✓	✓
GU-02	RGB 1ch output/audio output	✓	✓	✓	✓	✓	✓	✓	✓	✓	✓	✓	✓	✓	✓	✓	✓	✓	✓	✓	✓	✓
GU-03	Sound output	✓	✓	✓	✓	✓	✓	✓	✓	✓	✓	✓	✓	✓	✓	✓	✓	✓	✓	✓	✓	✓
GU-10	Video 2ch input/ RGB 1ch input	✓	✓	✓	✓	✓	✓	✓	✓	✓	✓	✓	✓	✓	✓	✓	✓	✓	✓	✓	✓	✓
GU-11	RGB 2ch input	✓	✓	✓	✓	✓	✓	✓	✓	✓	✓	✓	✓	✓	✓	✓	✓	✓	✓	✓	✓	✓
DU-10	Option unit for V806 (Dsub9+CF card)																✓	✓	✓	✓	✓	✓
Cables																						
V-CP	Screen program transfer cable (3m)	✓	✓	✓	✓	✓	✓	✓	✓	✓	✓	✓	✓	✓	✓	✓	✓	✓	✓	✓	✓	✓
UA-FR	USB-A panel surface fixing cable (1m)	✓	✓	✓	✓	✓	✓	✓	✓	✓	✓	✓	✓	✓	✓	✓	✓	✓	✓	✓	✓	✓
UB-FR	USB-B panel surface fixing cable (1m)	✓	✓	✓	✓	✓	✓	✓	✓	✓	✓	✓	✓	✓	✓	✓	✓	✓	✓	✓	✓	✓
V6-MLT	Multi-link 2 master cable (3m)	✓	✓	✓	✓	✓	✓	✓	✓	✓	✓	✓	✓	✓	✓	✓	✓	✓	✓	✓	✓	✓
V6-TMP	Temperature controller cable (3.5,10m)	✓	✓	✓	✓	✓	✓	✓	✓	✓	✓	✓	✓	✓	✓	✓	✓	✓	✓	✓	✓	✓
V6-BCD	Barcode reader cable(3m)	✓	✓	✓	✓	✓	✓	✓	✓	✓	✓	✓	✓	✓	✓	✓	✓	✓	✓	✓	✓	✓
MJ-D25	MJ-Dsub25 conversion cable	✓	✓	✓	✓	✓	✓	✓	✓	✓	✓	✓	✓	✓	✓	✓	✓	✓	✓	✓	✓	✓
MJ2-PLC	MJ2-Dsub25 conversion cable for V806/V706	✓	✓	✓	✓	✓	✓	✓	✓	✓	✓	✓	✓	✓	✓	✓	✓	✓	✓	✓	✓	✓
D9-MB-CPUQ	mitsubishi electric A/ QnA series CPU RS-422 (2.3.5,10,15m)	✓	✓	✓	✓	✓	✓	✓	✓	✓	✓	✓	✓	✓	✓	✓	✓	✓	✓	✓	✓	✓
D9-QCPU2	mitsubishi electric Q series CPU RS-232C (2.3.5,10,15m)	✓	✓	✓	✓	✓	✓	✓	✓	✓	✓	✓	✓	✓	✓	✓	✓	✓	✓	✓	✓	✓
D9-MI2-09	mitsubishi electric link unit RS-232C (2.3.5,10,15m)	✓	✓	✓	✓	✓	✓	✓	✓	✓	✓	✓	✓	✓	✓	✓	✓	✓	✓	✓	✓	✓
D9-MI4-FX	mitsubishi electric FX series CPU RS-422 (2.3.5,10,15m)	✓	✓	✓	✓	✓	✓	✓	✓	✓	✓	✓	✓	✓	✓	✓	✓	✓	✓	✓	✓	✓
D9-FU-SPHCPU	FUJII ELECTRIC SPH CPU RS-485 (4-wire) (2.3,5m)	✓	✓	✓	✓	✓	✓	✓	✓	✓	✓	✓	✓	✓	✓	✓	✓	✓	✓	✓	✓	✓
D9-FU-SPBCPU	FUJII ELECTRIC SPB CPU RS-485 (4-wire) (2.3,5m)	✓	✓	✓	✓	✓	✓	✓	✓	✓	✓	✓	✓	✓	✓	✓	✓	✓	✓	✓	✓	✓
V706-ACPU	mitsubishi electric A/ QnA series CPU RS-422 (2.3,5m)	✓	✓	✓	✓	✓	✓	✓	✓	✓	✓	✓	✓	✓	✓	✓	✓	✓	✓	✓	✓	✓
MJ2-MI4FX	mitsubishi electric FX series CPU RS-422 (2.3,5m)	✓	✓	✓	✓	✓	✓	✓	✓	✓	✓	✓	✓	✓	✓	✓	✓	✓	✓	✓	✓	✓
MJ2-FU-SPHCPU	FUJII ELECTRIC SPH CPU RS-485 (4-wire) (2.3,5m)	✓	✓	✓	✓	✓	✓	✓	✓	✓	✓	✓	✓	✓	✓	✓	✓	✓	✓	✓	✓	✓
MJ2-FU-SPBCPU	FUJII ELECTRIC SPB CPU RS-485 (4-wire)	✓	✓	✓	✓	✓	✓	✓	✓	✓	✓	✓	✓	✓	✓	✓	✓	✓	✓	✓	✓	✓
V8H-C	External connection cable for V808CH (3.5,15,20m)																✓	✓	✓	✓	✓	✓
D9-D25	Dsub9-Dsub25 conversion cable (0.3m)	✓	✓	✓	✓	✓	✓	✓	✓	✓	✓	✓	✓	✓	✓	✓	✓	✓	✓	✓	✓	✓
D9-D15	Dsub9-Dsub15 conversion cable (0.5m)	✓	✓	✓	✓	✓	✓	✓	✓	✓	✓	✓	✓	✓	✓	✓	✓	✓	✓	✓	✓	✓
Communication Terminal Block																						
TC-D9	Terminal converter for V8	✓	✓	✓	✓	✓	✓	✓	✓	✓	✓	✓	✓	✓	✓	✓	✓	✓	✓	✓	✓	✓
Card recorder																						
USB-CFREC	USB CF card recorder	✓	✓	✓	✓	✓	✓	✓	✓	✓	✓	✓	✓	✓	✓	✓	✓	✓	✓	✓	✓	✓
Battery																						
V7-BT	Battery for V8, V7, and V606e	✓	✓	✓	✓	✓	✓	✓	✓	✓	✓	✓	✓	✓	✓	✓	✓	✓	✓	✓	✓	✓
Switch guard cover																						
V8H-SWG	Switch guard cover for V808CH																✓	✓	✓	✓	✓	✓
Wall-hanging clasp																						
V6H-WF	Wall-hanging clasp set (for V808CH/V608CH)																✓	✓	✓	✓	✓	✓
V6H-WF1	Wall-hanging bracket (wall side) (for V808CH/V608CH)																✓	✓	✓	✓	✓	✓
V8H-WFV	Fitting for V808CH (VESA-compliant)																✓	✓	✓	✓	✓	✓
V8H-ST	Stand for V808CH																✓	✓	✓	✓	✓	✓
Protection sheet																						
V806-GS	V806 protection sheets																✓	✓	✓	✓	✓	✓
V806-GSN10	V806 protection sheets (Non-glare)																✓	✓	✓	✓	✓	✓
V608CH-GSN10	V808/V806 protection sheets (Non-glare)																✓	✓	✓	✓	✓	✓
V808-GS	Surface protection sheets for V808																✓	✓	✓	✓	✓	✓
V808-GSN10	Surface protection sheets for V808 (Non-glare)																✓	✓	✓	✓	✓	✓
V810-GS	Surface protection sheets for V810																✓	✓	✓	✓	✓	✓
V810-GSN10	Surface protection sheets for V810 (Non-glare)																✓	✓	✓	✓	✓	✓
V812-GS	Surface protection sheets for V812																✓	✓	✓	✓	✓	✓
V812-GSN10	Surface protection sheets for V812 (Non-glare)																✓	✓	✓	✓	✓	✓
V715-GS	Surface protection sheets for V815/V715																✓	✓	✓	✓	✓	✓
V715-GSN10	Surface protection sheets for V815/V715(Non-glare)																✓	✓	✓	✓	✓	✓
Backlight																						
V808C-FL ³	Backlight for V808C series																✓	✓	✓	✓	✓	✓
V808S-FL ³	Backlight for V808S series																✓	✓	✓	✓	✓	✓
V810-FL ³	Backlight for V810S/T/C series																✓	✓	✓	✓	✓	✓
V812-FL ³	Backlight for V812S series																✓	✓	✓	✓	✓	✓
V715-FL ³	Backlight for V815iX/V715 series																✓	✓	✓	✓	✓	✓

*1: Optional unit (DU-10) is required.
 *2: Used both MJ1/MJ2 ports.
 *3: CCFL type (Ver. a to q only).

Manufacturer	Models	connection form				V8	V9
		1:1	1:n Multi-drop	n:1 Multi-link2	n:1 Multi-link		
Allen-Bradley	PLC-5	✓	✓	✓	✓	✓	✓
	PLC-5 (Ethernet)	✓	✓	✓	✓	✓	✓
	Control Logix / Compact Logix	✓	✓	✓	✓	✓	✓
	Control Logix (Ethernet)	✓	✓	✓	✓	✓	✓
	SLC500	✓	✓	✓	✓	✓	✓
	SLC500 (Ethernet TCP/IP)	✓	✓	✓	✓	✓	✓
	NET-ENI (SLC500 Ethernet TCP/IP)	✓	✓	✓	✓	✓	✓
	NET-ENI (MicroLogix Ethernet TCP/IP)	✓	✓	✓	✓	✓	✓
	Micro Logix	✓	✓	✓	✓	✓	✓
	Micro Logix (Ethernet TCP/IP)	✓	✓	✓	✓	✓	✓
Automationdirect	Micro800 Controllers	✓	✓	✓	✓	✓	✓
	Micro800 Controllers (Ethernet TCP/IP)	✓	✓	✓	✓	✓	✓
	Direct LOGIC (K-Sequence)	✓	✓	✓	✓	✓	✓
Azbil	Direct LOGIC (Ethernet UDP/IP)	✓	✓	✓	✓	✓	✓
	Direct LOGIC (MODBUS RTU)	✓	✓	✓	✓	✓	✓
Baumüller	MX series	✓	✓	✓	✓	✓	✓
BECKHOFF	BMx-PLC	✓	✓	✓	✓	✓	✓
	ADS protocol (Ethernet)	✓	✓	✓	✓	✓	✓
CIMON	BP series	✓	✓	✓	✓	✓	✓
	CP series	✓	✓	✓	✓	✓	✓
	S series	✓	✓	✓	✓	✓	✓
DELTA	S series (Ethernet)	✓	✓	✓	✓	✓	✓
	DVP series	✓	✓	✓	✓	✓	✓
EATON Cutler-Hammer	ELC	✓	✓	✓	✓	✓	✓
EMERSON	EC10/20/20H (MODBUS RTU)	✓	✓	✓	✓	✓	✓
FANUC	Power Mate	✓	✓	✓	✓	✓	✓
Fatek Automation	FACON FB series	✓	✓	✓	✓	✓	✓
FUFENG	APC Series Controller	✓	✓	✓	✓	✓	✓
Fuji Electric	MICREX-F series	✓	✓	✓	✓	✓	✓
	MICREX-F series V4-compatible	✓	✓	✓	✓	✓	✓
	MICREX-F T-Link	✓	✓	✓	✓	✓	✓
	MICREX-F T-Link V4-compatible	✓	✓	✓	✓	✓	✓
	SPB (N mode) & FLEX-PC series	✓	✓	✓	✓	✓	✓
	SPB (N mode) & FLEX-PC CPU	✓	✓	✓	✓	✓	✓
	MICREX-SX (T-Link)	✓	✓	✓	✓	✓	✓
	MICREX-SX (OPCN-1)	✓	✓	✓	✓	✓	✓
	MICREX-SX (SX bus)	✓	✓	✓	✓	✓	✓
	MICREX-SX SPH/SPB/SPM/SPE series	✓	✓	✓	✓	✓	✓
MICREX-SX SPH/SPB/SPM/SPE CPU	✓	✓	✓	✓	✓	✓	
MICREX-SX (Ethernet)	✓	✓	✓	✓	✓	✓	
GE Fanuc	90 series	✓	✓	✓	✓	✓	✓
	90 series (SNP-X)	✓	✓	✓	✓	✓	✓
	90 series (SNP)	✓	✓	✓	✓	✓	✓
	90 series (Ethernet TCP/IP)	✓	✓	✓	✓	✓	✓
Hitachi	RX3i (Ethernet TCP/IP)	✓	✓	✓	✓	✓	✓
	HIDIC-S10/2alpha.S10mini	✓	✓	✓	✓	✓	✓
	HIDIC-S10/2alpha.S10mini (Ethernet)	✓	✓	✓	✓	✓	✓
	HIDIC-S10/4alpha	✓	✓	✓	✓	✓	✓
Hitachi Industrial Equipment Systems	HIDIC-S10V	✓	✓	✓	✓	✓	✓
	HIDIC-S10V (Ethernet)	✓	✓	✓	✓	✓	✓
	HIDIC-H	✓	✓	✓	✓	✓	✓
HYUNDAI	HIDIC-EHV	✓	✓	✓	✓	✓	✓
	HIDIC-EHV (Ethernet)	✓	✓	✓	✓	✓	✓
	Hi5Robot (MODBUS RTU)	✓	✓	✓	✓	✓	✓
IDEC	Hi4Robot (MODBUS RTU)	✓	✓	✓	✓	✓	✓
	MICRO 3	✓	✓	✓	✓	✓	✓
JTEKT	MICRO Smart	✓	✓	✓	✓	✓	✓
	MICRO Smart pentra	✓	✓	✓	✓	✓	✓
	TOYOPUC	✓	✓	✓	✓	✓	✓
	TOYOPUC (Ethernet)	✓	✓	✓	✓	✓	✓
KEYENCE	TOYOPUC (Ethernet PC10 mode)	✓	✓	✓	✓	✓	✓
	TOYOPUC-Plus	✓	✓	✓	✓	✓	✓
	TOYOPUC-Plus (Ethernet)	✓	✓	✓	✓	✓	✓
	KZ series link	✓	✓	✓	✓	✓	✓
	KZ-A500 CPU	✓	✓	✓	✓	✓	✓
	KV10/24 CPU	✓	✓	✓	✓	✓	✓
	KV-700	✓	✓	✓	✓	✓	✓
KOYO ELECTRONICS	KV-700 (Ethernet TCP/IP)	✓	✓	✓	✓	✓	✓
	KV-1000	✓	✓	✓	✓	✓	✓
	KV-1000 (Ethernet TCP/IP)	✓	✓	✓	✓	✓	✓
	KV-3000/5000	✓	✓	✓	✓	✓	✓
	KV-3000/5000 (Ethernet TCP/IP)	✓	✓	✓	✓	✓	✓
	SU/SG	✓	✓	✓	✓	✓	✓
LS	SR-T (K protocol)	✓	✓	✓	✓	✓	✓
	SU/SG (K-Sequence)	✓	✓	✓	✓	✓	✓
	SU/SG (Modbus RTU)	✓	✓	✓	✓	✓	✓
	MASTER-KxxxS	✓	✓	✓	✓	✓	✓
MITSUBISHI ELECTRIC	MASTER-KxxxS CNET	✓	✓	✓	✓	✓	✓
	MASTER-K series (Ethernet)	✓	✓	✓	✓	✓	✓
	GLOFA CNET	✓	✓	✓	✓	✓	✓
	GLOFA GM7 CNET	✓	✓	✓	✓	✓	✓
	GLOFA GM series CPU	✓	✓	✓	✓	✓	✓
	GLOFA GM series (Ethernet UDP/IP)	✓	✓	✓	✓	✓	✓
	XGT/XGK series CNET	✓	✓	✓	✓	✓	✓
	XGT/XGK series CPU	✓	✓	✓	✓	✓	✓
	XGT/XGK series (Ethernet)	✓	✓	✓	✓	✓	✓
	XGT/XGI series CNET	✓	✓	✓	✓	✓	✓
XGT/XGI series CPU	✓	✓	✓	✓	✓	✓	
XGT/XGI series (Ethernet)	✓	✓	✓	✓	✓	✓	
MITSUBISHI ELECTRIC	A series link	✓	✓	✓	✓	✓	✓
	A series CPU	✓	✓	✓	✓	✓	✓
	A series (OPCN-1)	✓	✓	✓	✓	✓	✓
	QnA series link	✓	✓	✓	✓	✓	✓
	QnA series CPU	✓	✓	✓	✓	✓	✓
	QnA series (Ethernet)	✓	✓	✓	✓	✓	✓
	QnH (Q) series link	✓	✓	✓	✓	✓	✓
	QnH (Q) series CPU	✓	✓	✓	✓	✓	✓
	QnU series CPU	✓	✓	✓	✓	✓	✓
	Q00J/00/01 CPU	✓	✓	✓	✓	✓	✓
QnH (Q) series (Ethernet)	✓	✓	✓	✓	✓	✓	
QnH (Q) series link (multi CPU)	✓	✓	✓	✓	✓	✓	
QnH (Q) series (multi CPU) (Ethernet)	✓	✓	✓	✓	✓	✓	
QnH (Q) series CPU (multi CPU)	✓	✓	✓	✓	✓	✓	

Manufacturer	Models	connection form				V8	V9
		1:1	1:n Multi-drop	n:1 Multi-link2	n:1 Multi-link		
MITSUBISHI ELECTRIC	QnH (Q) series (Ethernet ASCII)	✓	✓	✓	✓	✓	✓
	QnH (Q) series (multi CPU) (Ethernet ASCII)	✓	✓	✓	✓	✓	✓
	QnU series (built-in Ethernet)	✓	✓	✓	✓	✓	✓
	L series link	✓	✓	✓	✓	✓	✓
	L series (built-in Ethernet)	✓	✓	✓	✓	✓	✓
	A series (CC-LINK)	✓	✓	✓	✓	✓	✓
	QnA series (CC-LINK)	✓	✓	✓	✓	✓	✓
	QnH(Q) series (CC-LINK)	✓	✓	✓	✓	✓	✓
	FX series CPU	✓	✓	✓	✓	✓	✓
	FX2N/1N series CPU	✓	✓	✓	✓	✓	✓
MODICON	FX1S series CPU	✓	✓	✓	✓	✓	✓
	FX series link (A protocol)	✓	✓	✓	✓	✓	✓
	FX-3U/3UC/3G series CPU	✓	✓	✓	✓	✓	✓
	FX-3U series (Ethernet)	✓	✓	✓	✓	✓	✓
	FX3U/3UC/3G series link (A protocol)	✓	✓	✓	✓	✓	✓
	A-Link + Net10	✓	✓	✓	✓	✓	✓
	Q170MCP (multi CPU)	✓	✓	✓	✓	✓	✓
	Q170 series (multi CPU) (Ethernet)	✓	✓	✓	✓	✓	✓
	MODBUS RTU	✓	✓	✓	✓	✓	✓
	MOELLER	PS4	✓	✓	✓	✓	✓
OMRON	SYSMAC C	✓	✓	✓	✓	✓	✓
	SYSMAC C(OPCN-1)	✓	✓	✓	✓	✓	✓
	SYSMAC CV	✓	✓	✓	✓	✓	✓
	SYSMAC CS1/CJ1	✓	✓	✓	✓	✓	✓
	SYSMAC CS1/CJ1 DNA	✓	✓	✓	✓	✓	✓
	SYSMAC CS1/CJ1 (Ethernet)	✓	✓	✓	✓	✓	✓
	SYSMAC CS1/CJ1 (Ethernet Auto)	✓	✓	✓	✓	✓	✓
	SYSMAC CS1/CJ1 DNA (Ethernet)	✓	✓	✓	✓	✓	✓
	FP Series (RS232C/422)	✓	✓	✓	✓	✓	✓
	FP Series (TCP/IP)	✓	✓	✓	✓	✓	✓
Panasonic	FP Series (UDP/IP)	✓	✓	✓	✓	✓	✓
	FP-X (TCP/IP)	✓	✓	✓	✓	✓	✓
	FP7 Series (RS232C/422)	✓	✓	✓	✓	✓	✓
RS Automation	FP7 Series (Ethernet)	✓	✓	✓	✓	✓	✓
	NX7/NX Plus Series (70P/700P/CCU+)	✓	✓	✓	✓	✓	✓
	N7/NX Series (70/700/750/CCU)	✓	✓	✓	✓	✓	✓
SAIA	NX700 Series (Ethernet)	✓	✓	✓	✓	✓	✓
	X8 Series	✓	✓	✓	✓	✓	✓
	X8 Series (Ethernet)	✓	✓	✓	✓	✓	✓
SAMSUNG	PCD	✓	✓	✓	✓	✓	✓
	PCD S-BUS (Ethernet)	✓	✓	✓	✓	✓	✓
	SPC series	✓	✓	✓	✓	✓	✓
SHARP	N_plus	✓	✓	✓	✓	✓	✓
	SECNET	✓	✓	✓	✓	✓	✓
	JW series	✓	✓	✓	✓	✓	✓
SINFONIA TECHNOLOGY	JW100/70H COM port	✓	✓	✓	✓	✓	✓
	JW20 COM port	✓	✓	✓	✓	✓	✓
	JW series (Ethernet)	✓	✓	✓	✓	✓	✓
Siemens	JW300 series	✓	✓	✓	✓	✓	✓
	JW311/312/321/322 series (Ethernet)	✓	✓	✓	✓	✓	✓
	JW331/332/341/342/352/362 series (Ethernet)	✓	✓	✓	✓	✓	✓
TOSHIBA	SELMART	✓	✓	✓	✓	✓	✓
	S5 PG port	✓	✓	✓	✓	✓	✓
	S7	✓	✓	✓	✓	✓	✓
	S7-200 PPI	✓	✓	✓	✓	✓	✓
	S7-200 (Ethernet ISOTCP)	✓	✓	✓	✓	✓	✓
	S7-300/400 MPI	✓	✓	✓	✓	✓	✓
	S7-300/400 (Ethernet ISOTCP)	✓	✓	✓	✓	✓	✓
	S7-300/400 (Ethernet TCP/IP PG protocol)	✓	✓	✓	✓	✓	✓
	S7-1200 (Ethernet ISOTCP)	✓	✓	✓	✓	✓	✓
	S7 PROFIBUS-DP	✓	✓	✓	✓	✓	✓
TECO	TI500/505	✓	✓	✓	✓	✓	✓
	TI500/505 V4 Compatible	✓	✓	✓	✓	✓	✓
	TP03 (MODBUS RTU)	✓	✓	✓	✓	✓	✓
TOSHIBA	TSX Micro	✓	✓	✓	✓	✓	✓
	T series /V series (T compatible)	✓	✓	✓	✓	✓	✓
	T series /V series (T compatible)(Ethernet UDP/IP)	✓	✓	✓	✓	✓	✓
TOYO DENKI	EX series	✓	✓	✓	✓	✓	✓
	nv series(Ethernet UDP/IP)	✓	✓	✓	✓	✓	✓
	TC200	✓	✓	✓	✓	✓	✓
TURCK	uGPCsx(OPCN-1)	✓	✓	✓	✓	✓	✓
	uGPCsx series	✓	✓	✓	✓	✓	✓
	uGPCsx CPU	✓	✓	✓	✓	✓	✓
Ultra Instruments	uGPCsx series (Ethernet)	✓	✓	✓	✓	✓	✓
	BL Series Distributed I/O (MODBUS TCP/IP)	✓	✓	✓	✓	✓	✓
	UIC CPU (MODBUS ASCII)	✓	✓	✓	✓	✓	✓
VIGOR	M90/M91/Vision Series (ASCII)	✓	✓	✓	✓	✓	✓
	Vision Series (ASCII Ethernet TCP/IP)	✓	✓	✓	✓	✓	✓
	M series	✓	✓	✓	✓	✓	✓
WAGO	750 series (MODBUS RTU)	✓	✓	✓	✓	✓	✓
	750 series (MODBUS Ethernet)	✓	✓	✓	✓	✓	✓
	XC Series (MODBUS RTU)	✓	✓	✓	✓	✓	✓
Yaskawa Electric	MEMOBUS	✓	✓	✓	✓	✓	✓
	CP9200SH/MP900	✓	✓	✓	✓	✓	✓
	MP2300 (MODBUS TCP/IP)	✓	✓	✓	✓	✓	✓
	CP/MP EXPANSION MEMOBUS (UDP/IP)	✓	✓	✓	✓	✓	✓
	MP2000 series	✓	✓	✓	✓	✓	✓
	MP2000 series (UDP/IP)	✓	✓	✓	✓	✓	✓
	FA-M3	✓	✓	✓	✓	✓	✓
	FA-M3R	✓	✓	✓	✓	✓	✓
	FA-M3/FA-M3R (Ethernet UDP/IP)	✓	✓	✓	✓	✓	✓
	FA-M3/FA-M3R (Ethernet UDP/IP ASCII)	✓	✓	✓	✓	✓	✓
Yokogawa Electric	FA-M3/FA-M3R (Ethernet TCP/IP)	✓	✓	✓	✓	✓	✓
	FA-M3/FA-M3R (Ethernet TCP/IP ASCII)	✓	✓	✓	✓	✓	✓
	FA-M3V	✓	✓	✓	✓	✓	✓
Others	FA-M3V (Ethernet)	✓	✓	✓	✓	✓	✓
	FA-M3V (Ethernet ASCII)	✓	✓	✓	✓	✓	✓
	Universal serial	✓	✓	✓	✓	✓	✓
	MODBUS RTU	✓	✓	✓	✓	✓	✓
	MODBUS RTU EXT Format	✓	✓	✓	✓	✓	✓
	MODBUS TCP/IP (Ethernet)	✓	✓	✓	✓	✓	✓
	MODBUS TCP/IP (Ethernet) Sub Station	✓	✓	✓	✓	✓	✓
	MODBUS TCP/IP (Ethernet) EXT Format	✓	✓	✓	✓	✓	✓
	MODBUS ASCII	✓	✓	✓	✓	✓	✓

Manufacturer	Models	connection form				V8	V9
		1:1	1:n Multi-drop	n:1 Multi-link2	n:1 Multi-link		
Agilent	4263 Series	✓		✓		✓	✓
	SDC10	✓	✓	✓	✓	✓	✓
	SDC20	✓	✓	✓	✓	✓	✓
	SDC21	✓	✓	✓	✓	✓	✓
	SDC30/31	✓	✓	✓	✓	✓	✓
	SDC35/36	✓	✓	✓		✓	✓
	SDC40A	✓	✓	✓	✓	✓	✓
	SDC40G	✓	✓	✓	✓	✓	✓
Azbil	DMC10	✓	✓	✓		✓	✓
	DMC50 (COM)	✓	✓	✓		✓	✓
	AHC2001	✓	✓	✓		✓	✓
	AHC2001+DCP31/32	✓	✓	✓		✓	✓
	DCP31/32	✓	✓	✓	✓	✓	✓
	NX (CPL)	✓	✓	✓	✓	✓	✓
	NX (MODBUS RTU)	✓	✓	✓	✓	✓	✓
	NX (MODBUS TCP/IP)	✓	✓	✓	✓	✓	✓
Banner	Presence PLUS (Ethernet/IP (TCP/IP))	✓	✓			✓	✓
Bosch Rexroth	IndraDrive	✓	✓			✓	✓
	LT400 Series (MODBUS RTU)	✓	✓	✓	✓	✓	✓
	DP1000	✓	✓	✓	✓	✓	✓
	DB1000B (MODBUS RTU)	✓	✓	✓	✓	✓	✓
	KR2000 (MODBUS RTU)	✓	✓	✓	✓	✓	✓
	LT230 (MODBUS RTU)	✓	✓	✓	✓	✓	✓
	LT300 (MODBUS RTU)	✓	✓	✓	✓	✓	✓
	LT830 (MODBUS RTU)	✓	✓	✓	✓	✓	✓
DELTA TAU DATA SYSTEMS	PMAC	✓	✓	✓	✓	✓	✓
	PMAC (Ethernet TCP/IP)	✓	✓			✓	✓
	PYX (MODBUS RTU)	✓	✓	✓		✓	✓
	PXR (MODBUS RTU)	✓	✓	✓		✓	✓
	PXG (MODBUS RTU)	✓	✓	✓		✓	✓
	PXH (MODBUS RTU)	✓	✓	✓		✓	✓
	PUM (MODBUS RTU)	✓	✓	✓		✓	✓
	F-MPC04P (Loader)	✓	✓	✓		✓	✓
	F-MPC series /FePSU	✓	✓	✓		✓	✓
	FVR-E11S	✓	✓	✓	✓	✓	✓
	FVR-E11S (MODBUS RTU)	✓	✓	✓		✓	✓
	FVR-C11S (MODBUS RTU)	✓	✓	✓		✓	✓
	FRENIC5000 G11S/P11S	✓	✓	✓	✓	✓	✓
	FRENIC5000 G11S/P11S (MODBUS RTU)	✓	✓	✓		✓	✓
	FRENIC5000 VG7S (MODBUS RTU)	✓	✓	✓		✓	✓
	FRENIC-HVAC/AQUA (MODBUS RTU)	✓	✓	✓	✓	✓	✓
	FRENIC-Mini (MODBUS RTU)	✓	✓	✓		✓	✓
	FRENIC-Eco (MODBUS RTU)	✓	✓	✓		✓	✓
	FRENIC-Multi (MODBUS RTU)	✓	✓	✓		✓	✓
	FRENIC-MEGA (MODBUS RTU)	✓	✓	✓		✓	✓
	FRENIC-MEGA SERVO(MODBUS RTU)	✓	✓	✓	✓	✓	✓
	HFR-C9K	✓	✓	✓		✓	✓
	HFR-C11K	✓	✓	✓		✓	✓
	PPMC (MODBUS RTU)	✓	✓	✓		✓	✓
	FALDIC-alpha series	✓	✓	✓		✓	✓
	FALDIC-W series	✓	✓	✓	✓	✓	✓
	PH series	✓	✓	✓	✓	✓	✓
	PHR (MODBUS RTU)	✓	✓	✓		✓	✓
	WA5000	✓	✓	✓		✓	✓
	APR-N (MODBUS RTU)	✓	✓	✓		✓	✓
	ALPHA5 (MODBUS RTU)	✓	✓	✓		✓	✓
	ALPHA5 Smart (MODBUS RTU)	✓	✓	✓	✓	✓	✓
	WE1MA (Ver. A)(MODBUS RTU)	✓	✓	✓	✓	✓	✓
	WE1MA (Ver. B)(MODBUS RTU)	✓	✓	✓	✓	✓	✓
	WSZ series	✓	✓	✓	✓	✓	✓
	WSZ series (Ethernet)	✓	✓			✓	✓
Gammaflux	TTC2100	✓	✓	✓		✓	✓
Hitachi Industrial Equipment Systems	SJ300 series	✓	✓	✓	✓	✓	✓
	SJ700 series	✓	✓	✓	✓	✓	✓
	X-SEL controller	✓	✓	✓		✓	✓
IAI	ROBO CYLINDER (RCP2/ERC)	✓	✓	✓	✓	✓	✓
	ROBO CYLINDER (RCS/E-CON)	✓	✓	✓	✓	✓	✓
	PCON/ACON/SCON (MODBUS RTU)	✓	✓	✓		✓	✓
KOGANEI	IBFL-TC	✓	✓	✓	✓	✓	✓
	FR-500	✓	✓	✓		✓	✓
	FR-V500	✓	✓	✓		✓	✓
	MR-J2S-A	✓	✓	✓	✓	✓	✓
	MR-J3-A	✓	✓	✓	✓	✓	✓
	MR-J3-T	✓	✓	✓	✓	✓	✓
	FR-E700	✓	✓	✓	✓	✓	✓
MOOG	J124-04x Series	✓	✓	✓		✓	✓
M-SYSTEM	R1M series (MODBUS RTU)	✓	✓	✓	✓	✓	✓

Manufacturer	Models	connection form				V8	V9
		1:1	1:n Multi-drop	n:1 Multi-link2	n:1 Multi-link		
	E5AK	✓	✓	✓	✓	✓	✓
	E5AK-T	✓	✓	✓	✓	✓	✓
	E5AN/E5EN/E5CN/E5GN	✓	✓	✓		✓	✓
	E5AR/E5ER	✓	✓	✓		✓	✓
	E5CK	✓	✓	✓	✓	✓	✓
	E5CK-T	✓	✓	✓	✓	✓	✓
	E5CN-HT	✓	✓	✓	✓	✓	✓
	E5EK	✓	✓	✓	✓	✓	✓
	E5ZD	✓	✓	✓	✓	✓	✓
	E5ZE	✓	✓	✓	✓	✓	✓
	E5ZN	✓	✓	✓	✓	✓	✓
	V600/620/680	✓	✓	✓		✓	✓
	KM20	✓	✓	✓	✓	✓	✓
	KM100	✓	✓	✓	✓	✓	✓
Orientalmotor	High-efficiency AR series (MODBUS RTU)	✓	✓	✓	✓	✓	✓
	CRK series (MODBUS RTU)	✓	✓	✓	✓	✓	✓
	MINAS A4 series	✓	✓	✓	✓	✓	✓
Panasonic	LP-400	✓		✓		✓	✓
	KW Series	✓	✓	✓	✓	✓	✓
	SR-Mini (MODBUS RTU)	✓	✓	✓		✓	✓
	CB100/CB400/CB500/CB700/CB900 (MODBUS RTU)	✓	✓	✓		✓	✓
	SR-Mini (Standard Protocol)	✓	✓	✓		✓	✓
	REX-F400/F700/F900 (Standard Protocol)	✓	✓	✓	✓	✓	✓
	SRV (MODBUS RTU)	✓	✓	✓		✓	✓
	MA900/MA901 (MODBUS RTU)	✓	✓	✓		✓	✓
	SRZ (MODBUS RTU)	✓	✓	✓		✓	✓
	FB100/FB400/FB900 (MODBUS RTU)	✓	✓	✓	✓	✓	✓
SANMEI	Cuty Axis	✓	✓	✓	✓	✓	✓
SanRex	DC AUTO (HKD type)	✓	✓	✓		✓	✓
SHARP	DS-30D	✓	✓	✓		✓	✓
	DS-32D	✓	✓	✓		✓	✓
SHIMADEN	SHIMADEN standard protocol	✓	✓	✓	✓	✓	✓
	C Series	✓	✓	✓	✓	✓	✓
	FC Series	✓	✓	✓	✓	✓	✓
	GC Series	✓	✓	✓	✓	✓	✓
	DCL-33A	✓	✓	✓		✓	✓
	JCx-300 Series	✓	✓	✓	✓	✓	✓
	PC-900	✓	✓	✓	✓	✓	✓
	PCD-33A	✓	✓	✓	✓	✓	✓
	ACS-13A	✓	✓	✓	✓	✓	✓
	ACD/ACR Series	✓	✓	✓	✓	✓	✓
	WCL-13A	✓	✓	✓	✓	✓	✓
SUS	XA-A*	✓		✓		✓	✓
	TTM-000	✓	✓	✓	✓	✓	✓
	TTM-00BT	✓	✓	✓		✓	✓
	TTM-200 (MODBUS RTU)	✓	✓	✓		✓	✓
TOKYO CHOKOKU PRODUCTS	MB3315/1010	✓		✓		✓	✓
	VF-S7	✓	✓	✓	✓	✓	✓
	VF-S9	✓	✓	✓	✓	✓	✓
	VF-S11	✓	✓	✓	✓	✓	✓
	VF-S15	✓	✓	✓	✓	✓	✓
	VF-A7	✓	✓	✓	✓	✓	✓
	VF-AS1	✓	✓	✓	✓	✓	✓
	VF-P7	✓	✓	✓	✓	✓	✓
	VF-PS1	✓	✓	✓	✓	✓	✓
	VF-FS1	✓	✓	✓	✓	✓	✓
	VF-nC1	✓	✓	✓	✓	✓	✓
	VF-nC3	✓	✓	✓	✓	✓	✓
TOSHIBA MACHINE	VELCONIC series	✓	✓	✓		✓	✓
ULVAC	G-TRAN series	✓	✓	✓		✓	✓
	F340A	✓	✓	✓	✓	✓	✓
	F371	✓	✓	✓	✓	✓	✓
	F800	✓	✓	✓	✓	✓	✓
	F720A	✓	✓	✓	✓	✓	✓
	F805A	✓	✓	✓	✓	✓	✓
YAMAHA	RCX142	✓		✓		✓	✓
	UT100	✓	✓	✓		✓	✓
	UT750	✓	✓	✓		✓	✓
	UT550	✓	✓	✓		✓	✓
	UT520	✓	✓	✓		✓	✓
	UT350	✓	✓	✓		✓	✓
	UT320	✓	✓	✓		✓	✓
	UT2400/2800	✓	✓	✓		✓	✓
	UT450	✓	✓	✓		✓	✓
Others	MODBUS RTU	✓	✓	✓	✓	✓	✓
	MODBUS TCP/IP (Ethernet)	✓	✓			✓	✓

Worldwide service network for trouble-free

Tel

FAX

Tel +81-76-274-2144 Fax +81-76-274-5136

E-mail

✉ sales@hakko-elec.co.jp

WEB

<http://www.monitouch.com/>



Global Sales Network

Our distributors are ready to support your worldwide business.

<http://monitouch.fujielectric.com/site/distributors-e/distributors-oversea-01.html>



operations

To the purchasers of Hakko Electronics products:

The warranty of this product is as follows, unless there are special instructions that state otherwise in the quote, contract, catalog, or specifications at the time of the quote or order.

The purpose or area of use may be limited, and a routine checkup may be required depending on the product. Please contact the distributor from which you purchased the product, or Hakko Electronics for further information.

Please conduct inspection of the product promptly upon purchase or delivery. Also, please give sufficient consideration to management and maintenance of the product prior to accepting it.

1 Period and Coverage of the Warranty

1-1 Period

- (1) The period of the warranty is effective until twenty-four (24) months from the date of manufacture printed on the plate.
- (2) The above period may not be applicable if the particular environment, conditions or frequency of use affects the lifetime of the product.
- (3) The warranty for the parts repaired by Hakko Electronics' service department is effective for six (6) months from the date of repair.

1-2 Coverage

- (1) If malfunction occurs during the period of warranty due to negligence on the part of Hakko Electronics, the malfunctioning parts are exchanged or repaired free of charge at the point of purchase or delivery. However, the warranty does not apply to the following cases:
 - 1) The malfunction occurs due to inappropriate conditions, environment, handling or usage that is not specified in the catalog, instruction book or users' manual.
 - 2) The malfunction is caused by factors that do not originate in the purchased or delivered product.
 - 3) The malfunction is caused by another device or software design that does not originate in a Hakko Electronics product.
 - 4) The malfunction occurs due to an alteration or repair that was not performed by Hakko Electronics.
 - 5) The malfunction occurs because the expendable parts listed in the instruction book or catalog were not maintained or replaced in an appropriate manner.
 - 6) The malfunction occurs due to factors that were not foreseeable by the practical application of science and technology at the time of purchase or delivery.
 - 7) The malfunction occurs because the product is used for a purpose other than that for which it is intended.
 - 8) The malfunction occurs due to a disaster or natural disaster that Hakko Electronics is not responsible for.
- (2) The warranty is only applicable to the single purchased and delivered product.
- (3) The warranty is only valid for the conditions stated in (1) above. Any damage induced by the malfunction of the purchased or delivered product, including damage or loss to a device or machine and passive damage, is not covered by the warranty.

1-3 Malfunction Diagnosis

The initial diagnosis of malfunction is to be made by the purchaser. The diagnosis can be conducted by Hakko Electronics or its delegated service provider with due charge upon the request of the purchaser. The charge is to be paid by the purchaser at the rate stipulated in the rate schedule of Hakko Electronics.

2 Liability for Opportunity Loss

Regardless of the time of occurrence, Hakko Electronics is not liable for damage caused by factors that Hakko Electronics is not responsible for, opportunity loss on the part of the purchaser caused by the malfunction of a Hakko Electronics product, passive damage, damage due to a special situation regardless of whether it was foreseeable or not, or secondary damage, accident compensation, damage to products that were not manufactured by Hakko Electronics, or compensation towards other operations.

3 Period for Repair and Provision of Spare Parts after Production is Discontinued (Maintenance Period)

Discontinued models (products) can be repaired for seven (7) years from the date of discontinuation. Also, most spare parts used for repair are provided for seven (7) years from the date of discontinuation. However, some electric parts may not be available due to their short life cycle. In this case, it may be difficult to repair or provide the parts during the seven-year period. Please contact Hakko Electronics or its service providers for further information.

4 Delivery

Standard products that do not entail application setting or adjustment are regarded as received by the purchaser upon delivery. Hakko Electronics is not responsible for local adjustments and test runs.

5 Service

The price of the delivered or purchased products does not include the service fee for the technician. Please contact Hakko Electronics or its service providers for further information.

6 Scope of Application

The above contents shall be assumed to apply to transactions and product use in the country where a Hakko Electronics product is purchased. Please consult your local supplier or Hakko Electronics for details.