

Characteristics

- Closing force 200N, 400N and 800N
- For heating or cooling valves
- Sturdy and reliable
- Temperature range 0 to 160°C
(-30 to 280°C on request)

Applications

The temperature controller, which consists of a thermostat and a valve, is used for controlling the temperature in central heating systems, district heating systems, industrial plants or industrial processes and in marine systems. It can be used for the control of cold or hot water, steam or oil in heating as well as cooling systems.

Function

The adjusting cylinder of the thermostat is set at the required temperature for the heating medium in °C. This setting can be fixed, if required. The temperature control is carried out by the thermostatically controlled valve reducing or increasing the flow of the heating (or cooling) medium. The sensor and the capillary tube, which are filled with a liquid, constitute - together with the adjusting cylinder - a closed system.

If the temperature of a medium to be heated is above the required level, the temperature of the sensor liquid rises and expands, causing the piston of the thermostat to act upon the valve, reducing the flow of the heating medium.

If the temperature of the medium to be heated is below the required level, the temperature of the sensor liquid falls, reducing the volume of the liquid, so that the piston allows the valve to open under its internal spring, thus increasing the flow of the heating medium.

The neutral zone of a thermostat is the temperature difference which can occur at the sensor without any movement of the valve spindle. This represents the sensitivity of the control system to temperature changes:

V2 = 2.5°C, V4 = 2 °C and V8 = 1.5°C.



Design

Thermostat

A thermostat consists of a sensor and a capillary tube, filled with liquid, and an adjusting cylinder.

The thermostat type designations and technical data are specified in fig. 2.

With temperatures above 150°C, a cooling unit must be fitted between the valve and the thermostat - see fig. 1.

The thermostat is self-acting and works on the principle of liquid expansion, it is sturdy in its design, and works with a large closing force.

Sensor

The following sensor types are available - see fig. 4:

- 4.1. Rod/spiral sensor in copper or stainless steel with threaded connection according to ISO R7/1.

- 4.2. Spiral sensor (copper only) with air duct flange.

- 4.3. Rod/spiral sensor with steel flange DN 50, PN 40 and DN 50, PN 160.

- 4.4. Sensor without connection. Usually used with capillary pack box for temperature control in tanks.

Capillary Tube

The capillary tube is made of copper, stainless steel, or of PVC-coated copper - see fig. 3, but can also be delivered with a flexible iron tube protection.

Valve

A wide range of valve types for heating as well as cooling systems can be delivered. See the „Quick Choice“ leaflet no. 9.0.00 and datasheets for the valves in question.

Subject to changes, without notice.

Choice of Temperature Control

The selection of the correct temperature controller is determined by the sizing of the valve and thermostat respectively, which may be chosen by using the „Quick Choice“ leaflet no. 9.0.00.

The designation of the thermostat is determined by using 3 elements, e.g. thermostat type V4.05, where V indicates type V thermostat, 4 indicates 0.01 x the force in Newton by which the thermostat can act upon the connected valve, and 05 relates to the travel of the thermostat spindle in mm by a temperature change of 1°C - see also fig. 2.

Fig. 1 indicates whether the temperature of the heating medium necessitates a cooling unit, and how the thermostat is to be mounted in relation to the valve; for a temperature range -30°C to 150°C the thermostat may be installed both above and below the valve.

Fig. 2 shows the type number of the thermostat, its closing force in N and its setting range in °C.

Fig. 3 shows the choices of length and material for the capillary tubes.

Fig. 4 shows the different types of sensors.

Fig. 5 shows the time coefficients for the sensors.

Fig. 6 shows the choices of sensor materials, etc.

Fig. 7 shows the dimensions and weights of the sensors etc.

Fig. 1. Temperature Limits

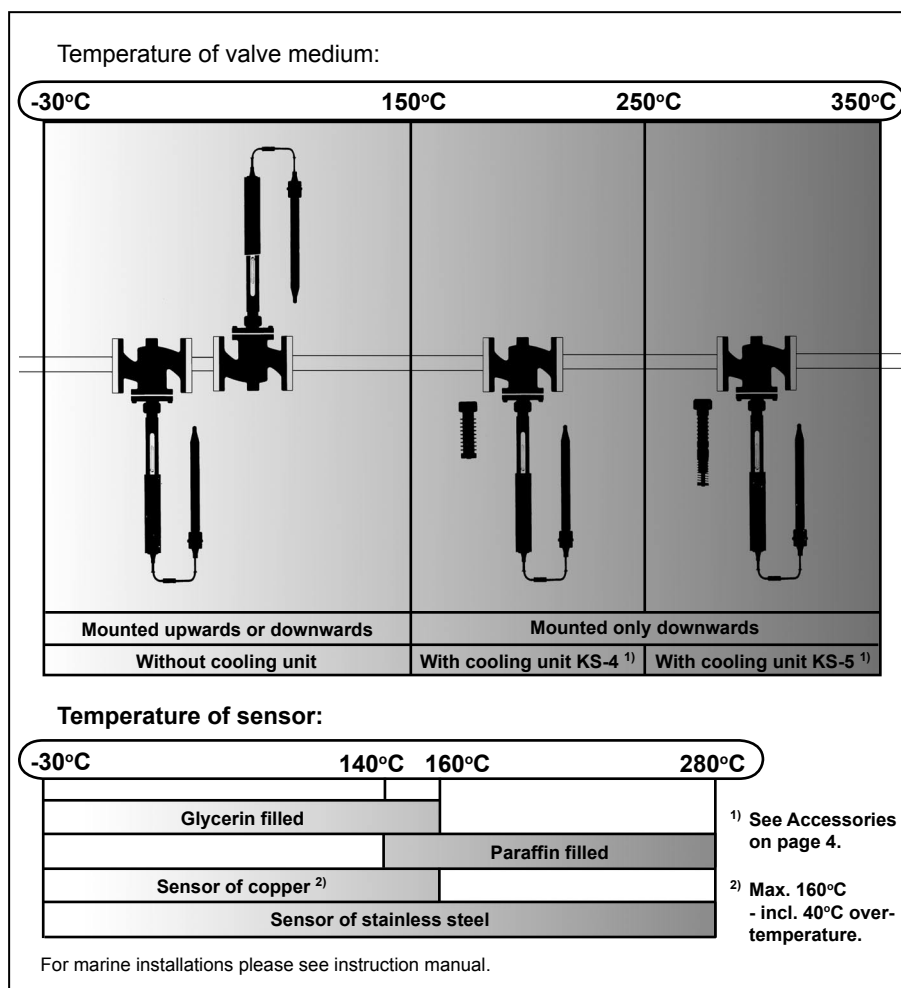

Fig. 2. Thermostat Types

Technical Data		Thermostat Types						
		V2.05	V4.03	V4.05	V4.10	V8.09	V8.18	
Max. closing force	N	200	400	400	400	800	800	
Setting range for standard thermostats ¹⁾	°C	0-60	0-160	0-120	0-60	0-120	0-60	
		30-90		40-160	30-90	40-160	30-90	
		60-120			60-120		60-120	
Neutral zone	°C	2,5	2	2	2	1,5	1,5	
For valves with rated travel up to:	mm	10	21	21	21	21	21	
Travel (amplification) in range:	mm/°C	-30 to 160°C ²⁾	0,5	0,3	0,5	1	0,9	1,8
		140 to 280°C ³⁾	0,7	0,33	0,7	1,33	1,2	2,4

¹⁾ Setting ranges from -30 to 280°C on request. - Excess temp. safety range: 40°C ²⁾ Glycerine ³⁾ Paraffin

Subject to changes, without notice.

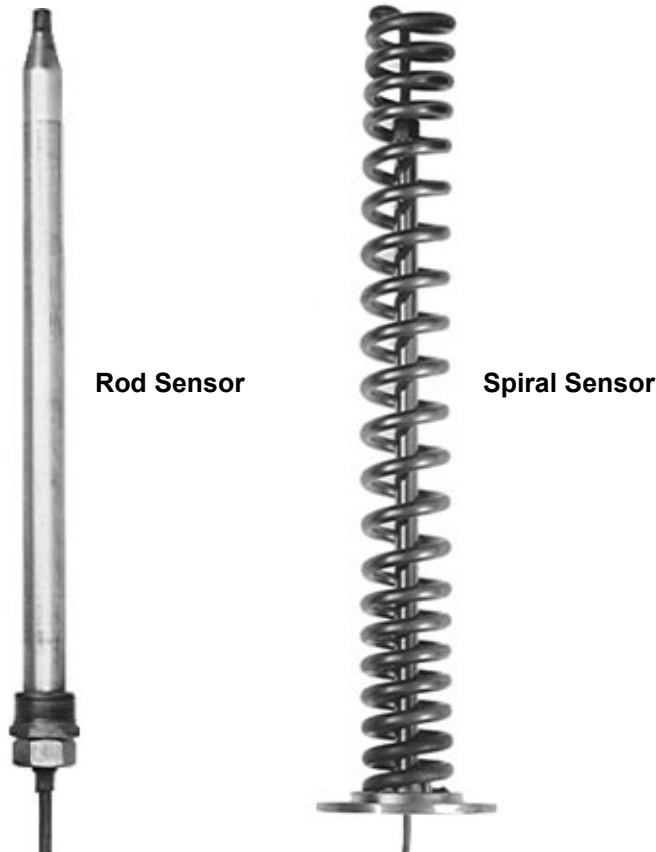

Fig. 3. Capillary Tubes

Choice of capillary tube, length and material, is determined according to the table below, independent of the choice of the thermostat type.

Length	Copper	PVC-coated copper	Stainless steel
3 m	•	•	•
4,5 m			•
6 m	•	•	•
7,5 m			•
9 m	•	•	•
10,5 m			•
12 m	•	•	•
13,5 m			•
15 m	•	•	•
16,5 m			•
18 m	•	•	•
19,5 m			•
21 m	•	•	•



Fig. 4. Sensor Types

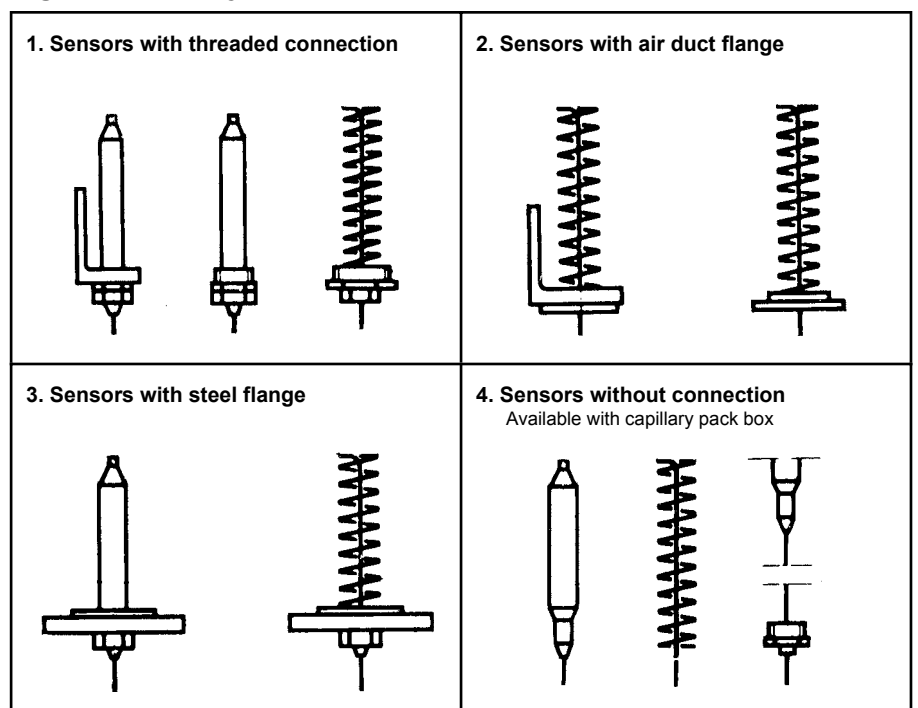

Subject to changes, without notice.

Fig. 5. Time Coefficient for Sensors

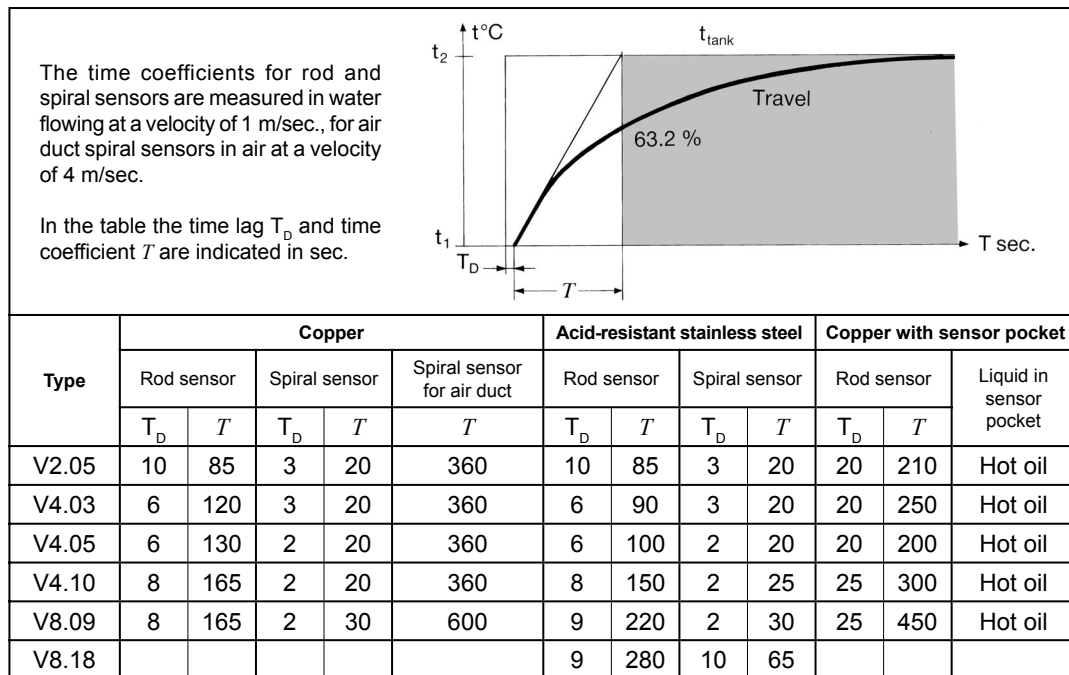
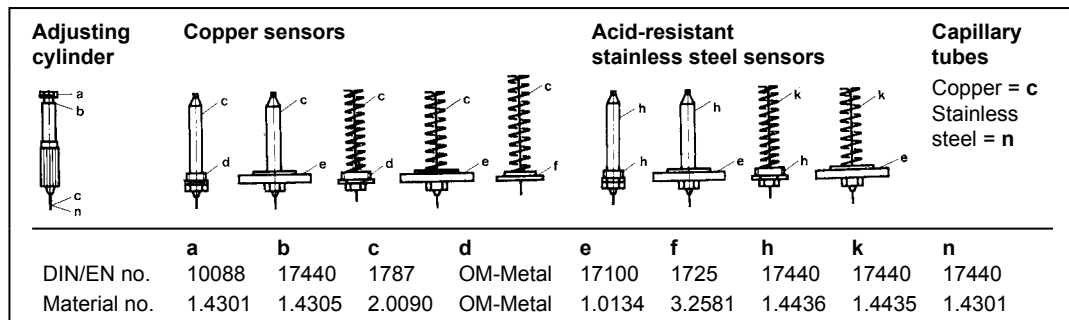
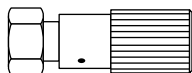

Fig. 6. Sensor Material etc.



Accessories

Manual Adjusting Device



With stuffing box. For tightening and manual operation of the valves, when an actuator has not been fitted, e.g. during periods of construction.

Cooling Unit KS-4

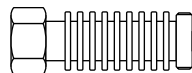

Cooling unit protecting the stuffing box of the motor/thermostat. To be applied at valve temperatures between 150 °C and 250 °C .

Cooling Unit KS-5

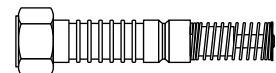

Cooling unit with built-in bellows gland. Replaces the stuffing box of thermostat. Must be applied by valve temperatures between 250 °C and 350 °C and in case of hot oil systems.

Subject to changes, without notice.

V2, V4 and V8 Thermostats Self Acting Temperature Controls

3.4.01-H

GB-5

Fig. 7. Dimensions and Weights

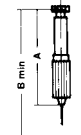
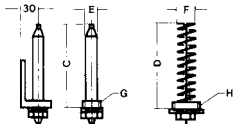
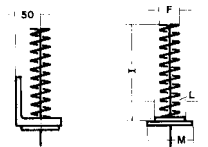
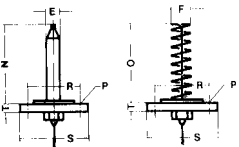
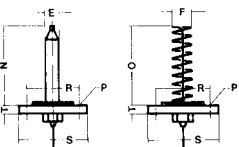
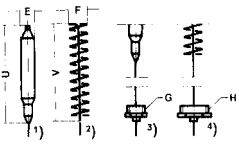
The measurements G and H are pipe threads according to ISO R7/1. All other measurements are mm. Weight: Net. c = Copper sensor. s = Acid-resistant stainless steel sensor.		Thermostat / Sensor material											
		Type V2.05		Type V4.03		Type V4.05		Type V4.10		Type V8.09		Type V8.18	
		c	s	c	s	c	s	c	s	c	s	c	s
Adjusting cylinder  Weights: see below	A	305	305	385	385	385	385	385	385	560	560		560
	B	405	405	525	525	525	525	525	525	740	740		740
Sensor with threaded connection  Weight incl. G-connection Weight incl. H-connection	C	210	190	210	190	390	380	490	515	710	745		800
	D	235	170	235	170	235	250	325	325	425	435		810
	E	22	22	22	22	22	22	28	25	28	25		34
	F	49	49	49	49	49	49	49	49	49	49		49
	G	R $\frac{3}{4}$	R $\frac{3}{4}$	R1	R1	R1	R1	R1	R1	R2	R2		R2
	H	R2	R2	R2	R2	R2	R2	R2	R2	R2	R2		R2
	kg	1,8	1,8	2,4	2,4	2,6	2,6	3,3	3,3	6,3	6,3		7,3
kg	2,3	2,3	2,9	2,9	3,1	3,1	3,8	3,8	6,3	6,3		7,3	
Sensors with air duct flange 	F	49		49		49		49		49			
	I	420		420		420		420		450			
	L	60		60		60		60		60			
	M	95		95		95		95		95			
	kg	1,8		2,4		2,6		3,3		5,8			
Sensor with steel flange DN 50, PN 40 	E	22	22	22	22	22	22	28	25	28	25		34
	F	49	49	49	49	49	49	49	49	49	49		49
	N	200	180	200	180	380	360	480	505	700	735		790
	O	225	160	225	160	225	240	315	315	415	425		800
	P	4x18	4x18	4x18	4x18	4x18	4x18	4x18	4x18	4x18	4x18		4x18
	R	125	125	125	125	125	125	125	125	125	125		125
	S	165	165	165	165	165	165	165	165	165	165		165
	T	22	22	22	22	22	22	22	22	22	22		22
	kg	5,3	5,3	5,9	5,9	6,1	6,1	6,8	6,8	9,3	9,3		10,3
	Sensor with steel flange DN 50, PN 160 	E	22	22	22	22	22	22	28	25	28	25	
F		49	49	49	49	49	49	49	49	49	49		49
N		180	160	180	160	360	340	460	485	680	715		770
O		205	140	205	140	205	220	295	295	395	405		780
P		4x27	4x27	4x27	4x27	4x27	4x27	4x27	4x27	4x27	4x27		4x27
R		145	145	145	145	145	145	145	145	145	145		145
S		195	195	195	195	195	195	195	195	195	195		195
T		45	45	45	45	45	45	45	45	45	45		45
kg		11,3	11,3	11,9	11,9	12,1	12,1	12,8	12,8	15,3	15,3		16,3
Sensors without connection Available with capillary pack box 		E	22	22	22	22	22	22	28	25	28	25	
	F	49	49	49	49	49	49	49	49	49	49		49
	G	R1	R1	R1	R1	R1	R1	R1	R1	R2	R2		R2
	H	R2	R2	R2	R2	R2	R2	R2	R2	R2	R2		R2
	U	250	230	250	230	430	410	535	555	750	785		840
	V	290	220	290	220	290	310	375	370	470	490		860
	kg ¹⁾	1,6	1,6	2,2	2,2	2,3	2,3	3	3	5,5	5,5		6,5
	kg ²⁾	1,6	1,6	2,2	2,2	2,4	2,4	3,1	3,1	5,6	5,6		6,6
	kg ³⁾	1,8	1,8	2,4	2,4	2,6	2,6	3,3	3,3	6,3	6,3		7,3
	kg ⁴⁾	2,3	2,3	2,9	2,9	3,1	3,1	3,8	3,8	6,3	6,3		7,3

Dimensional Sketch

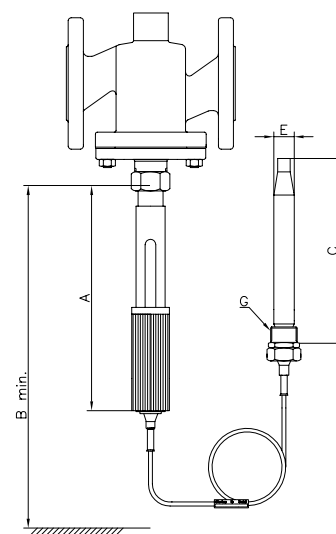

Subject to changes,
without notice.