

ConVey

ECONOMICAL
THREE-PIECE BALL VALVES
1/4" TO 4" FULL PORT 800/1000 PSI

DESIGN ADVANTAGES

- For general Industrial and Chemical applications.
- Three-piece swing-out design allows in-line maintenance.
- Full port orifice minimizes pressure drop and prolong life.
- Blow-out proof stem.
- Available in stainless steel and carbon steel.
- Investment cast body construction.

SPECIFICATIONS

Construction : Three-Piece Body, Full Bore
Size : 1/4" to 4" (DN 8 to DN 100)
Body : CF8M, WCB / DIN 1.4408, 1.0619
Ball and Stem : 316 S.S.
Seat : PTFE
Pressure Rating : 800/1000 PSI

VALVE FIG. NO. AND END CONNECTIONS:

- FIG. 50-10 THREADED END
- FIG. 50-20 SOCKET WELD
- FIG. 50-30 BUTT WELD
- FIG. 50-40 EXTENDED BUTT WELD
- FIG. 50-50 FLANGED END (PN 25/40 F1)

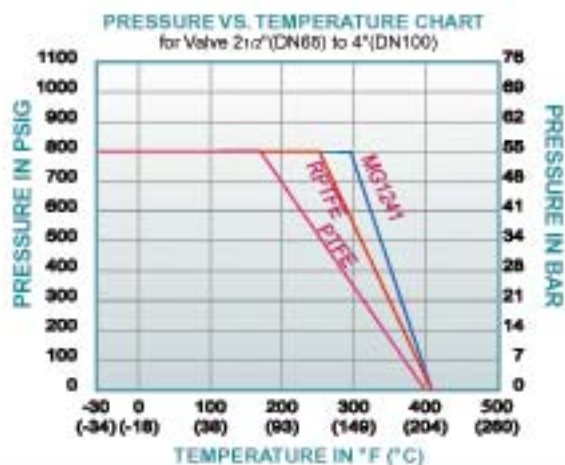
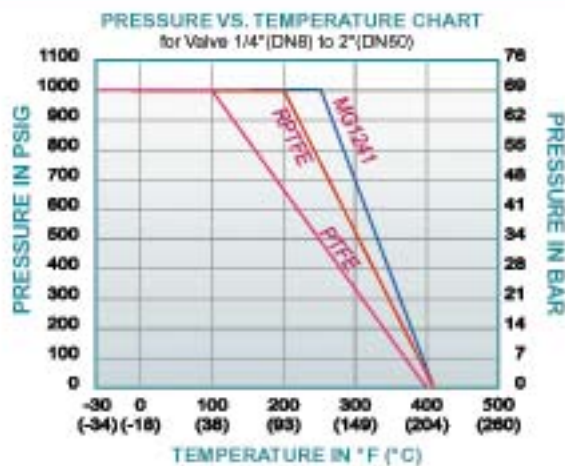

OPTION

Mounting Brackets and Couplers



FIG. 50-10



FIG. 50-20



FIG. 50-30



FIG. 50-40



FIG. 50-50



SERIES 50

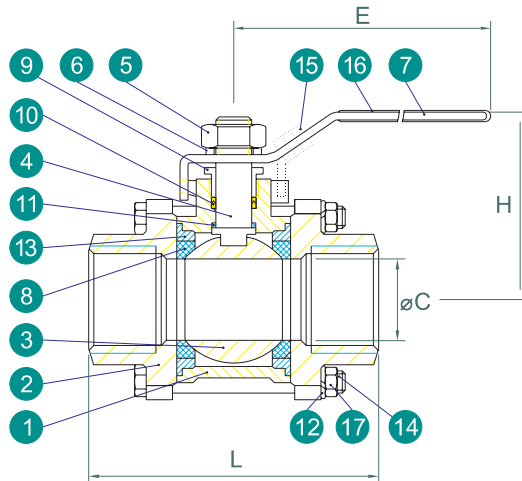
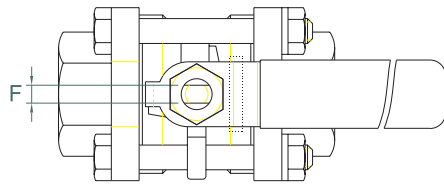

50-10
THREADED END



50-20
SOCKET WELD
END

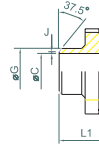

50-30
BUTT WELD
END

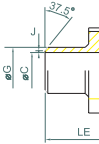

50-40
EXTENDED BUTT
WELD END

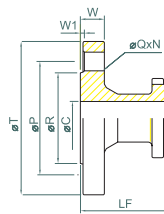

50-50
FLANGE END
(PN25/40 F1)

MATERIALS LIST

NO.	PART NAME	MATERIAL		Q'TY
1	Body	CF8M	WCB	1
2	End Cap	CF8M	WCB	2
3	Ball	SUS 316		1
4	Stem	SUS 316		1
5	Stem Nut	SUS 304		1
6	Stem Washer	SUS 304		1
7	Handle	SUS 304		1
8	Seat	PTFE		2
9	Gland Nut	SUS 304		1
10	V-Ring Packing	PTFE		§
11	Stem Seal	PTFE		1
12	Bolt Washer	SUS 304		f
13	Joint Gasket	PTFE		2
14	Bolt	SUS 304		*
15	‡ Locking Device	SUS 304		1
16	Handle Sleeve	Vinyl		1
17	Bolt Nut	SUS 304		f

- § For 1/4" & 3/8" regular 1pc stem packing is used instead
For 1/2" & 3" 1 set of v-ring packing consists of 2pcs of v-ring
For 4" 1 set of v-ring packing consists of 3pcs of v-ring
- f For 1/4" to 2"-4pcs; For 2 1/2" & 3" -8pcs; For 4" -12pcs
- * For 1/4" to 2"-4pcs of bolts (single ended external thread)
For 2 1/2" to 3"-4pcs of studs (double ended external thread)
For 4" -6pcs of studs (double ended external thread)
- ‡ Available as an option

DIMENSIONS (mm)

SIZE	øA	øC	E	F	øG	H	J	L	L1	L2	LE	LF	N	øP	øQ	øR	øT	W	W1	W(Kg)
1/4"	14.1	11.6	100	5.0	14.0	50	1.6	56.6	56.6	10	225	N/A	N/A	N/A	N/A	N/A	N/A	N/A	N/A	0.35
3/8"	17.6	12.7	100	5.0	17.5	50	1.6	56.6	56.6	10	225	N/A	N/A	N/A	N/A	N/A	N/A	N/A	N/A	0.33
1/2"	21.7	15.0	130	6.5	22.7	60	1.6	65.5	65.5	10	225	130	4	65	14	45	95	16	2	0.56
3/4"	27.3	20.0	130	6.5	27.5	64	1.6	76.2	76.2	13	225	150	4	75	14	58	105	18	2	0.75
1"	34.1	25.0	165	8.0	33.5	71	1.6	86	86	13	245	160	4	85	14	68	115	18	2	1.035
1 1/4"	42.8	32.0	165	8.0	42.0	78	1.6	102.8	102.8	13	255	180	4	100	18	78	140	18	2	1.74
1 1/2"	48.7	38.0	190	9.7	48.6	86	1.6	119	119	13	260	200	4	110	18	88	150	18	3	2.41
2"	61.0	50.0	190	9.7	60.5	95	1.6	131.4	131.4	16	275	230	4	125	18	102	165	20	3	3.66
2 1/2"	ANSI 73.5 PN 76.6	65.0	250	12.0	76.3	130	2.0	164	164	16	334	290	8	145	18	122	185	22	3	7.1
3"	90.0	80.0	250	12.0	90.0	148	2.0	182.5	182.5	16	354	310	8	160	18	138	200	24	3	10.5
4"	115.2	100	280	15.0	116.0	185	3.5	235.6	236.2	20	365	350	8	190	22	162	235	24	3	20.76

HOW TO ORDER

50-10

05

S

P

VALVE TYPE		SIZE	BODY & END MATERIAL			SEAT	
50-10	Threaded End	01 1/4"	S	CF8M	P	Virgin PTFE	
50-20	Socket Weld End	02 3/8"	W	WCB	R	R-PTFE	
50-30	Butt Weld End	03 1/2"	L	316L S. S.	S	50/50 St. St. filled PTFE	
50-40	Extended Butt Weld End	04 3/4"	F	304 S. S.	C	Carbon filled PTFE	
50-50	Flanged End(PN 25/40 F1)	05 1"			M	MG1241	
		06 1 1/4"			D	Delrin	
		07 1 1/2"			U	UHMWPE	
		08 2"					
		09 2 1/2"					
		10 3"					
		11 4"					