

WP- Dynamic

Turbine Water Meter
for hot water up to 130 °C
DN 40 ... DN 300



Special Features

- Patented hydrodynamically balanced rotor
- Patented symmetrical calibration adjustment
- Hermetically sealed register (IP 68)
- Register may be rotated through 360°
- High overload capability
- Pattern approved removable measuring element
- Up to 3 pulsers (1 x OD, 2 x RD) may be fitted without breaking the approval seal
- Powder coating ensures maximum corrosion protection

Hot water meters Pressure rate PN 40 please see special leaflet

Application

Measurement of high, relatively constant flow rates

Pattern Approval

22.16	Nominal Diameter DN 50 ... 150
96.01	Marking: Metrological class B

UK & Ireland Enquiries
Sensus Metering Systems
11 The Quadrangle, Abbey Park,
Romsey, Hampshire SO51 9DL UK
T: +44 (0) 1794 526100
F: +44 (0) 1794 526101
Email: info.gb@sensus.com

www.sensus.com

International Enquiries
Sensus Metering Systems GmbH Ludwigshafen
Industriestrasse 16,
67063 Ludwigshafen Germany
T: +49 (0) 621-6904-0
F: +49 (0) 621-6904-1409
Email: info.int@sensus.com

www.sensus.com



Installation

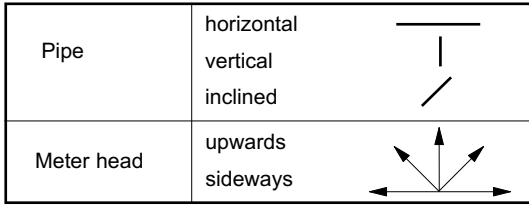

Installation Requirements

- Unrestricted straight pipe in front of the meter 3 x DN
- No abrupt restrictions directly behind the meter

Technical Data

Performance data WP-Dynamic QH 130 °C

Nominal Diameter		DN	40	50	65	80	100	125	150	200	250	300
Size of meter (acc. to PTB-A22)		Q _n	10	15	25	40	60	100	150	250	400	600
Q _{max}	maximum peak flow once lifetime 24 h Q _{max} or 5 min. 1.2 x Q _{max}	m ³ /h	20	30	60	90	140	200	300	500	1000	1200
Q _n	continuous flow (±2%)	m ³ /h	10	15	25	45	70	100	150	250	500	600
Q _t	transitional flow (±2%)	m ³ /h	1.8	1.8	2.0	3.2	4.8	8.0	12	20	45	50
Q _{min}	minimum flow (±5%)	m ³ /h	0.6	0.6	1.0	1.4	2.0	3.5	4.5	8	20	25
	starting flow	m ³ /h	0.25	0.25	0.3	0.35	0.6	1.1	1.7	2.0	10	15

Performance data table according to PTB-A22 specification class B

Nominal Diameter		DN	50	65	80	100	125	150	200	250	300
Size of meter (acc. to PTB-A22)		Q _n	15	25	40	60	100	150	250	400	600
Q _{max}	maximum peak flow short time	m ³ /h	30	50	80	120	200	300	500	800	1200
Q _n	continuous flow (±3%)	m ³ /h	15	25	40	60	100	150	250	400	600
Q _t	transitional flow (±3%)	m ³ /h	2.25	3.75	6.0	9.0	15.0	22.5	37.5	60	90
Q _{min}	minimum flow (±5%)	m ³ /h	0.6	1.0	1.6	2.4	4.0	6.0	10.0	16.0	24.0

Typical Accuracy Curve

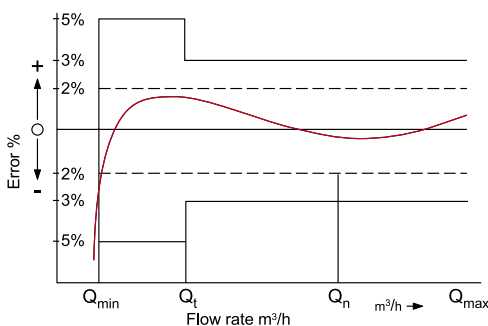

- Q_{max} = maximum peak flow
- Q_n = continuous flow ±2%
- Q_t = transitional flow ±2%
- Q_{min} = minimum flow ±5%

Typical Head Loss Curve

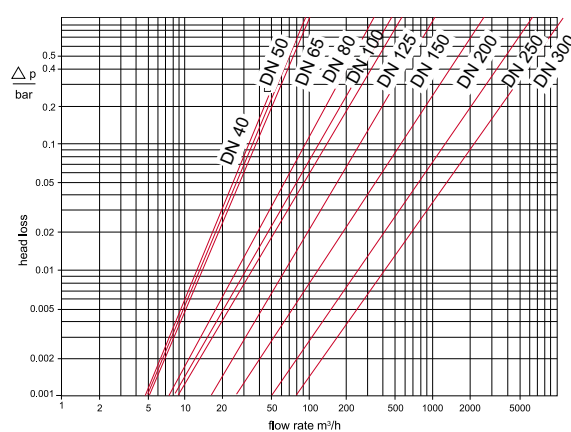

WP-Dynamic for hot water

Dimensions and Weights

Nominal Diameter	DN	40	50	65	80	80	100	125	150	200	250	300		
Size of meter (acc. to PTB-A22)	Q _n	10	15	25	40	40	60	100	150	250	400	600		
Dimensions	overall length L *)	mm	220	200	200	200	225	250	250	300	350	450	500	
	height	H	mm	120	120	120	150	150	150	160	177	206	231	256
		h	mm	69	73	85	95	95	105	118	135	162	194	226
		g	mm	200	200	200	270	270	270	280	356	441	466	491
Weights	meter	kg	7.4	7.7	10.0	13.6	14.0	18.0	20.5	35.5	50.5	72.3	99.3	
	measuring element	kg	1.4	1.4	1.4	3.0	3.0	3.0	3.0	5.5	7.5	7.5	7.5	
	body	kg	6.0	6.3	8.6	10.6	11.0	15.0	17.5	30.0	43.0	71.3	91.8	

*) Other overall lengths on request

Dimension Picture

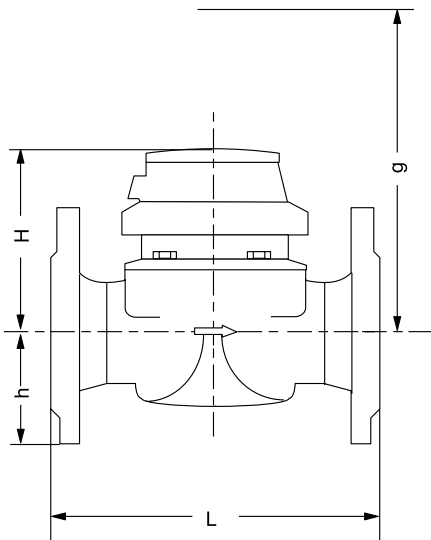

Materials

Body	cast iron
Measuring element	plastic
Rotor	plastic
We also use the following materials	brass stainless steel

Dials

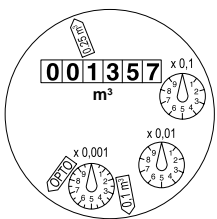

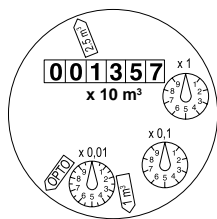

DN 40 ... DN 125



DN 150 ... DN 300

Nominal Diameter DN	Smallest reading m ³	Max. reading m ³
40 ... 125	0.0005	1 000 000
150 ... 300	0.005	10 000 000

Pulse Values

Pulser		pulse value	
		DN 40 ... DN 125	DN 150 ... DN 300
RD02 / RD022		0.1 and 0.25 m ³ alternatively 0.025 and 0.25 m ³	1 and 2.5 m ³ alternatively 0.25 and 2.5 m ³
OD 02		0.001 m ³	0.01 m ³
OD 04		0.01 m ³	0.1 m ³

Order Text

Quantity:

Specification: WP-Dynamic

Nominal Diameter: DN

Size of meter: Qn

Working temperature: 130 °C

Working pressure: PN 16

Metrological class: A / B

Overall length L: mm

Pulse values: / m³

Flange drilling: acc. to DIN 2501, PN 16

Certification: with / without

Order Example

Quantity: 3

Specification: WP-Dynamic

Nominal Diameter: DN 50

Size of meter: Qn 15

Working temperature: 130 °C

Working pressure: PN 16

Metrological class: B

Overall length L: 200 mm

Pulse values: 0.25 / 0.1 m³

Flange drilling: acc. to DIN 2501, PN 16

Certification: with