



偉允閥業股份有限公司
WYECO AUTO VALVES CO., LTD.



HEAT-MEDIUM THREE-WAY CONTROL VALVE

WY-D22TD

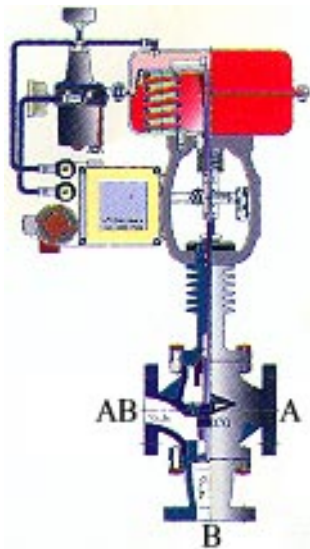

WY-D32TD



Heat-medium three-way control valves are generally used either to mix flowing medium or to divert one medium into two outlet flows and are often used when fluid temperature is to be adjusted through heat exchangers.

Mixing type valves can also be used for diverting service when both the valve size and pressure differential are small. However, the mixing type is more suitable when the valve size is larger than 3" and the pressure differential is also considerable.

Specification

Body

Type: Mixing service three-way valve.
Diverting service three-way valve.

Material: Ductile iron (FCD450),
Carbon steel (SCPH2), Stainless steel (SCS13, SCS14)

Size: 1/2", 3/4", 1", 1-1/4", 1-1/2", 2", 3", 4", 5", 6".

End connection: Flanged end (FF, RF).

Rating: JIS10k, 20k, 30k. ANSI 150, 300, 600lb.

Bonnet: 1.Plain bonnet (0-under 200°C)
2.Radiator Fin (0-300°C)
3.Bellows Seal (0-350°C)

Packing: Carbon graphite.

Guide: Top and bottom guide.

Trim

Valve plug: three-way.

Plug form: Equal percentage, linear.

Material: Stainless steel (SUS304, SUS316 with stellite coating furnished to the seat).

Actuator

Type: Spring type Diaphragm actuated, direct or reverse action.

Diaphragm material: Neoprene with fabric insert.

Spring range: 0.2-1.0kg/cm².
0.4-2.0kg/cm²

Air to diaphragm: 1.4-2.8 kg/cm².

Pneumatic tubing connection: 1/4" female tap.

Ambient temperature: -20~+60°C

Valve action

Air to open or air to close by using direct or reverse actuator.

Accessory

Positioner, limit switch, air set and others

Performance

Leakage of full closure: Less than 0.01% of rated Cv.

Rangeability: 30:1

ABOUT WYECO

PRODUCTS INDEX

■ [Proportional Diaphragm Actuated Valve](#)

■ [Cylinder Actuated Valve](#)

■ [Y-Type Cylinder Actuated Valve](#)

■ [Diaphragm/Cylinder Actuated Diaphragm Valve](#)

■ [Heat-Medium Three-Way Control Valve](#)

■ [Hyper-Cryogenic Emergency Shut-Off Valve](#)

■ [Cylinder Actuated Ball Valve](#)

■ [Electrical Actuated Valve](#)

HOW TO ORDER



WYECO AUTO VALVES CO., LTD.

Office:4F, No. 98, Sec. 3, Chien Kuo North Road, Taipei, Taiwan, R.O.C.

TEL:886-2-2502-5166(REP) FAX:886-2-2501-2863

Factory:No. 6, Lane 2, Shanlin Road, Sec. 3, Luchu Hsiang, Taoyuan Hsien, Taiwan, R.O.C.

TEL:(03)3245116~7, 3244056~8 FAX:(03)3245196

E-mail:wysal@ms15.hinet.net

<http://www.wyeco.com.tw>

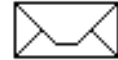

[mail to us](mailto:wysal@ms15.hinet.net)



Home

Copyright © 1998 WYECO AUTO VALVES CO., LTD.



偉允閥業股份有限公司
WYECO AUTO VALVES CO., LTD.



CYLINDER ACTUATED VALVE

WY-C08GS

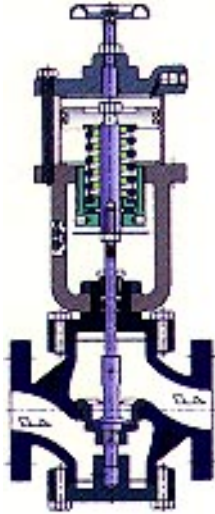

Model WY-C08GS series are actuated by Cylinder. They provide high thrust because of their greater range of supply pressure, and also can provide a long stroke. Cylinder-type actuators, are suitable for applications where compactness or a higher thrust than that of diaphragm actuators are required. They are also installed for on-off, emergency shut-off control system.

Specification

Body

Type: Single seated, direct or reverse type, globe valve.
3 way diverting or mixing type.

Material: Cast iron (FC250), Ductile iron (FCD450),
Carbon steel (SCPH2),
Stainless steel (SCS13, SCS14)

Size: 1/2", 3/4", 1", 1-1/4", 1-1/2", 2", 3", 4", 5", 6".

End connection: Flanged end (FF, RF).

Rating: JIS10k, 20k, 30k. ANSI 150, 300, 600lb.

Bonnet: Plain bonnet (0-under 200°C)
Radiator finned bonnet (200°C or over).

Packing: V-teflon, Asbestos yarn and Carbon graphite.

Guide: Top and bottom guide, top guide.

Trim

Valve plug: Single seated, three-way



Plug form: Teflon seat plug for on-off service

Material: Stainless steel (SUS304, SUS316 with stellite coating furnished to the seat).

Actuator

Type: Spring return cylinder actuated, direct or reverse.

Double-action cylinder acuated.

Cylinder material: Aluminum Alloy, Anodized.

Operating air pressure: 3~5kg/cm².

Pneumatic tubing connection: 1/4" female tap.

Ambient temperature: -20 ~ +60°C

Valve action

Air to open or air to close by using direct or reverse actuator.

Accessory

Handwheel

Positioner, limit switch, air set & lubricator

Performance

Leakage of full closure: Class VI

Service:

For steam, air, water, oil and other fluids.

Operating Air Pressure: 3-5 kg/cm²G

Remark:

Up to 4" are double acting cylinder actuator.

Connection Rating JIS 10K.

ABOUT WYECO

PRODUCTS INDEX

■ [Proportional Diaphragm Actuated Valve](#)

■ [Cylinder Actuated Valve](#)

■ [Y-Type Cylinder Actuated Valve](#)

■ [Diaphragm/Cylinder Actuated Diaphragm Valve](#)

■ [Heat-Medium Three-Way Control Valve](#)

■ [Hyper-Cryogenic Emergency Shut-Off Valve](#)

■ [Cylinder Actuated Ball Valve](#)

■ [Electrical Actuated Valve](#)

HOW TO ORDER



WYECO AUTO VALVES CO., LTD.

Office:4F, No. 98, Sec. 3, Chien Kuo North Road, Taipei, Taiwan, R.O.C.

TEL:886-2-2502-5166(REP) FAX:886-2-2501-2863

Factory:No. 6, Lane 2, Shanlin Road, Sec. 3, Luchu Hsiang, Taoyuan Hsien,
Taiwan, R.O.C.

TEL:(03)3245116~7, 3244056~8 FAX:(03)3245196

E-mail:wysal@ms15.hinet.net

<http://www.wyeco.com.tw>

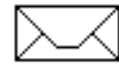

[mail to us](#)



Copyright © 1998 WYECO AUTO VALVES CO., LTD.



偉允閥業股份有限公司
WYECO AUTO VALVES CO., LTD.



PROPORTIONAL DIAPHRAGM ACTUATED VALVE

W Y - D 0 2 G S

W Y - D 0 2 G C

W Y - D 0 2 G D

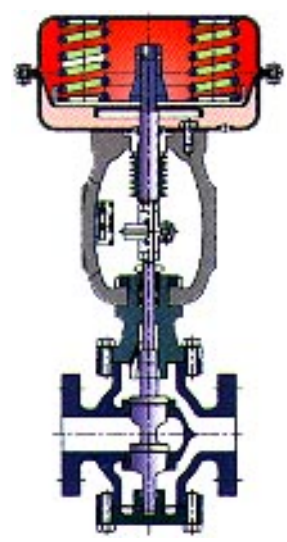
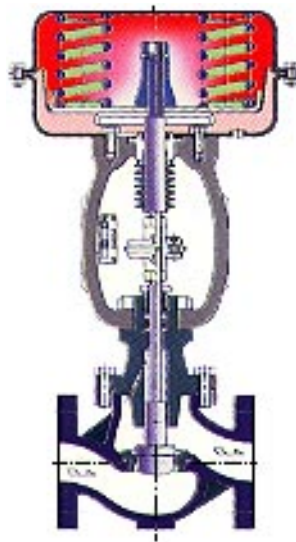
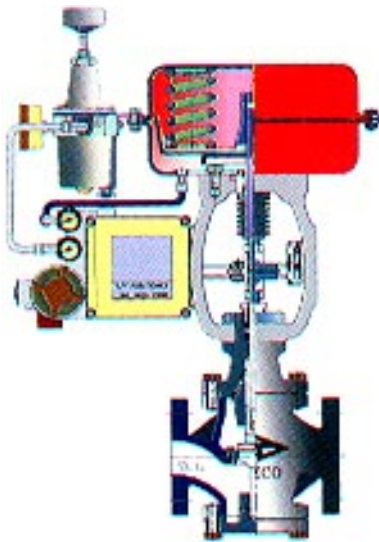

Model WY-D02GS control valve are operated by pneumatic signals from any suitable temperature, level, flow or pressure controller and ease of adjustment.

Specification

Body

Type: Single seated, direct or reverse type, globe valve.

Material: Cast iron (FC250), Ductile iron (FCD450),
Carbon steel (SCPH2),
Stainless steel (SCS13, SCS14)

Size: 1/2", 3/4", 1", 1-1/4", 1-1/2", 2", 3", 4", 5", 6".

End connection: Flanged end (FF, RF).

Rating: JIS10k, 20k, 30k. ANSI 150, 300, 600lb.

Bonnet: Plain bonnet (0-under 200°C)

Radiator finned bonnet (200°C or over).

Packing: V-teflon, Asbestos yarn and Carbon graphite.

Guide: Top and bottom guide, top guide.

Trim

Valve plug: Single seated (Double seated)

Plug form: Equal percentage, linear and On-off.

Material: Stainless steel (SUS304, SUS316 with stellite coating furnished to the seat).

Actuator

Type: Spring type Diaphragm actuated, direct or reverse.

Diaphragm material: Neoprene with fabric insert.

Spring range: 0.2-1.0kg/cm².
 0.4-2.0kg/cm²

Air to diaphragm: 1.4-2.8 kg/cm².

Pneumatic tubing connection: 1/4" female tap.

Ambient temperature: -20~+60°C

Valve action

Air to open or air to close by using direct or reverse actuator.

Accessory

Handwheel

Positioner, limit switch, air set or others

Performance

Rangeability: 35:1

Leakage of full closure: Less than 0.01% of rated Cv.

ABOUT WYECO

PRODUCTS INDEX

■ [Proportional Diaphragm Actuated Valve](#)

■ [Cylinder Actuated Valve](#)

■ [Y-Type Cylinder Actuated Valve](#)

■ [Diaphragm/Cylinder Actuated Diaphragm Valve](#)

■ [Heat-Medium Three-Way Control Valve](#)

■ [Hyper-Cryogenic Emergency Shut-Off Valve](#)

■ [Cylinder Actuated Ball Valve](#)

■ [Electrical Actuated Valve](#)

HOW TO ORDER



WYECO AUTO VALVES CO., LTD.

Office:4F, No. 98, Sec. 3, Chien Kuo North Road, Taipei, Taiwan, R.O.C.

TEL:886-2-2502-5166(REP) FAX:886-2-2501-2863

Factory:No. 6, Lane 2, Shanlin Road, Sec. 3, Luchu Hsiang, Taoyuan Hsien,
Taiwan, R.O.C.

TEL:(03)3245116~7, 3244056~8 FAX:(03)3245196

E-mail:wysal@ms15.hinet.net

<http://www.wyeco.com.tw>



[mail to us](#)



Home

Copyright © 1998 WYECO AUTO VALVES CO., LTD.



偉允閥業股份有限公司
WYECO AUTO VALVES CO., LTD.



Y-TYPE CYLINDER ACTUATED VALVE

WY-C08YT-S

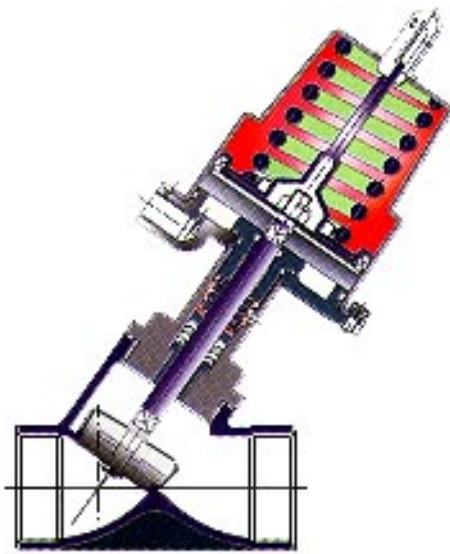

WY-C08YT-F

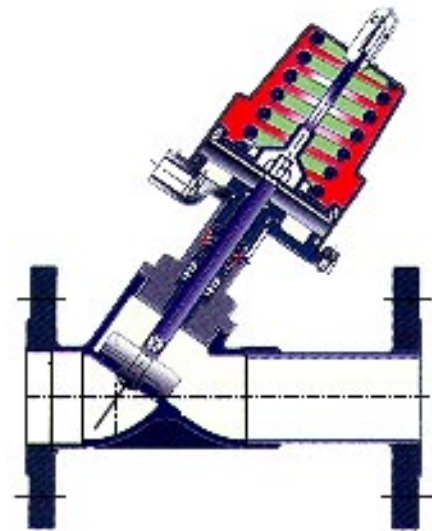

Features

- Compact, Light weight, High quality
- High flow capacity
- Simple design, Easy to assembly
- Easy to install and maintain
- All stainless made, Good for corrosive atmosphere

Specification

Item	Specification
Actuating Method	Cylinder

Actuating Parts	Poiston and spring	
Actuating Media	Air	
Actuating Temperature	Max. 80°C	
Material of Actuating Parts	Piston: SUS304	
	Spring: SAE9254	
	Cylinder: SUS304	
Material of Main Parts	Valve body: SCS 14A (Precision Casting)	
	Seat ring: SUS 316	
	Valve plug stem: SUS 316	
	Stem seal: TEFLON	
Gland packing: TEFLON		
Fluid Direction	As teh tag shows on cylinder	
Fluid Temperature	-25°C~180°C	
Size	1/2"~2" Screwed type, Socketwelded type, Flanged type	
Connection Rating	JIS 10K, 20K. ANSI 150LB, 300LB. PN 16, 25	
Viscosity	Max. 400 cst	
Actuator	Model	WY-C08YT-S(-F)
	Actuation	Spring return, Normal close
	Operating Pressure	3~5 kg/cm2
	Fluid Pressure	0~10 kg/cm2
	Atmosphere Temp.	-10°C~80°C
	Optional	Solenoid valve

ABOUT WYECO

PRODUCTS INDEX

- | | |
|---------------------------------------------------------------|------------------------------------------------------------|
| ■ Proportional Diaphragm Actuated Valve | ■ Heat-Medium Three-Way Control Valve |
| ■ Cylinder Actuated Valve | ■ Hyper-Cryogenic Emergency Shut-Off Valve |
| ■ Y-Type Cylinder Actuated Valve | ■ Cylinder Actuated Ball Valve |
| ■ Diaphragm/Cylinder Actuated Diaphragm Valve | ■ Electrical Actuated Valve |

HOW TO ORDER



WYECO AUTO VALVES CO., LTD.

Office:4F, No. 98, Sec. 3, Chien Kuo North Road, Taipei, Taiwan, R.O.C.

TEL:886-2-2502-5166(REP) FAX:886-2-2501-2863

Factory:No. 6, Lane 2, Shanlin Road, Sec. 3, Luchu Hsiang, Taoyuan Hsien,
Taiwan, R.O.C.

TEL:(03)3245116~7, 3244056~8 FAX:(03)3245196

E-mail:wysal@ms15.hinet.net

<http://www.wyeco.com.tw>



[mail to us](#)



Home

Copyright © 1998 WYECO AUTO VALVES CO., LTD.